

Continuous Ionized KANGEN and Acidic Water Generator



Leveluk Super 501

LIFE SCIENCE WATER APPARATUS

Operation Manual

- Be sure to read this manual carefully thoroughly.
- Please use this unit correctly according to manufacturers instructions.
- Keep this manual in safety for future reference.

Thank you very much for purchasing our < **Leveluk Super 501** >.
Before using, please read through this Operation Manual carefully for your safety and convenience. Please keep this manual in a safe place for future use.

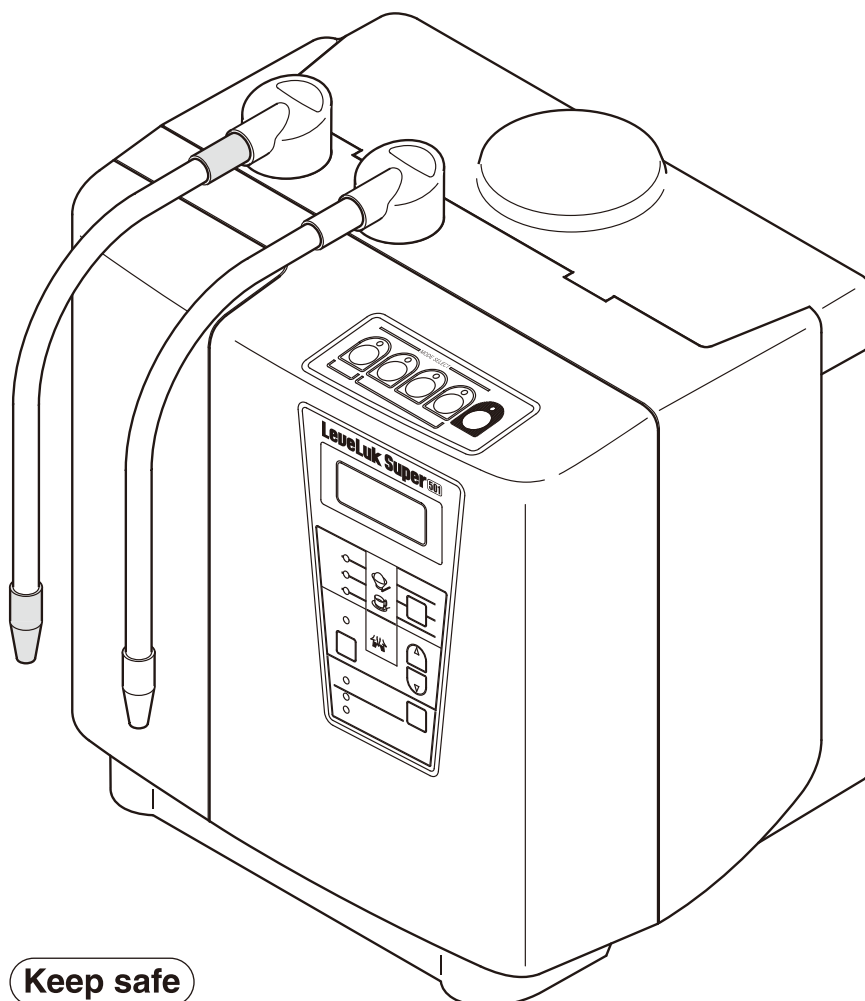

Keep safe

Los Angeles :

4115 Spencer Street Torrance, CA 90503-2419
TEL. +1-310-542-7700 FAX. +1-310-542-1700

New York :

3636 33rd street Suite 101 Long Island City NY 11106
TEL. +1-718-784-2110 FAX. +1-718-784-2103

Chicago :

1154 S. Elmhurst Rd. Mount Prospect, IL 60056-4241
TEL. +1-847-430-4013 FAX. +1-847-437-8201

Honolulu :

Ala Moana Pacific Center, Suite 711 1585 Kapiolani Boulevard
Honolulu, Hawaii 96814
TEL. +1-808-949-5300 FAX. +1-808-949-5336

Texas :

545 Rowlett Road Suite A Garland, TX 75043
TEL. +1-972-316-7985 FAX. +1-310-531-7111

Seattle :

18920 28th Ave. W Suite 105 Lynnwood, WA 98036
TEL. +1-425-640-2222 FAX. +1-425-672-8946

Orlando :

8803 Futures Drive, Unit 01 Orlando, FL 32819
TEL. +1-407-601-5963 FAX. +1-407-630-6081

Burnaby :

101-7460 Edmonds Street Burnaby BC V3N 1B2
TEL. +1-604-214-0065 FAX. +1-604-214-0067

Toronto :

Unit 23 - 156 Duncan Mill Rd North York, ON,
M3B 3N2, Canada
TEL. +1-905-507-1200 FAX. +1-416-445-6594

Mexico :

Av Vasconcelos 345 col Santa Engracia
San Pedro Garza Garcia Nuevo Leon, Mexico
TEL. +52-81-8242-5500 FAX. +52-81-8242-5549

Brazil :

Rua Joao Dos Santos,532 Jardim Santa Rosalia,
Sorocaba, Sao Paulo 18090-040, Brazil
TEL. +55-15-3034-4132 FAX. +55-15-3034-4100

Germany :

Charlottenstr. 73 40210 Düsseldorf, Germany
TEL. +49-211-936570-00 FAX. +49-211-936570-27

France :

8-10 avenue ledru-Rollin 3rd floor 75012 Paris France
TEL. +33 (0) 1 47 07 55 65 FAX. +33 (0) 1 83 71 17 06

Italy :

Via Marco Aurelio, 35 00184, Rome, Italy
TEL. +39-6-3330-670 FAX. +39-6-3321-9505

Australia :

Suite 15, 33 Waterloo Road, Macquarie Park NSW 2113, Australia
TEL. +61-2-9878-1100 FAX. +61-2-9878-1200

Russia :

Letnikovskaya Str. 10 Bld. 4, Floor 1 115114, Moscow, Russia
TEL. +7-495-988-02-05 FAX. +7-495-988-02-06

Romania :

68-70 6th floor 500397 Braşov, Romania
TEL. +40-374028779

Portugal :

Av. de França, nº 735 4250 214 Porto, Portugal
TEL. +351-22-8305464

Hong Kong :

Unit 1615-17
16th Floor Mira Place Tower A 132 Nathan Rd., Tsim Sha Tsui Kowloon,
Hong Kong TEL. +852-2154-0077 FAX. +852-2154-0027

Taiwan :

Asia World Bldg. 12B., No.337, Sec. 3, Nanjing E. Rd., Songshan Dist.,
Taipei City 105, Taiwan, R.O.C
TEL. +886-2-2713-2936 FAX. +886-2-2713-2938

Philippines :

Unit 3-4, 16th Floor RCBC Savings Bank Corporate Center
Bonifacio Global City Taguig City, Metro Manila
TEL. +63-2-519-5508 FAX. +63-2-519-1923

Korea(Seoul) :

7F Heeseung BD, 15, Seolleung-ro 131-gil, Gangnam-gu, Seoul,
Korea 06060
TEL. +82-2-546-8120 FAX. +82-2-546-8127

Korea (Busan) :

S-213 Lotte gallerium,9,Centum 1-ro, Haeundae-gu,Busan
TEL. +82-51-744-8822 FAX. +82-51-744-8833

Singapore :

111 North Bridge Road, #25-04 Peninsula Plaza Singapore 179098
TEL. +65-6720-7501 FAX. +65-6720-7505

Malaysia :

UNIT NO 25-6 & 27-6, The Boulevard, Mid Valley city Lingkaran Syed
Putra, 59200 Kuala Lumpur, Malaysia
TEL. +60-3-2282-2332 FAX. +60-3-2282-2335

Indonesia :

The Plaza Office Tower, Lt.20
Jl. M.H. Thamrin Kav.28-30 10350 Jakarta Indonesia
TEL. +62-21-2992-3111 FAX. +62-21-2992-8111

Thailand :

19 Floor, Unit 1903-1904 Sathorn Square Office Tower,
98 North Sathorn Rd, Silom, Bangrak, Bangkok 10500, Thailand
TEL. +66-2-163-2869 FAX. +66-2-163-2879

India :

The Millenia Tower B, 4th Floor, Unit 401, No. 1 and 2, Murphy Road,
Ulsoor Bangalore 560-008 India.
TEL. +91-80-4650-9900 FAX. +91-80-4650-9908

Mongolia :

Sukhbaatar district 4khoroo 5-kharoolol Sain Neyen
khan Namnsuren Street 37 building No.1, Mongolia-976
TEL. +976-7012-7778 FAX. +976-7012-7708

Dubai :

Office No.105, Hassanacor Building, Al Barsha First, Dubai, UAE
TEL. +971 4 395 5011 FAX. +971 4 395 5150

Tokyo :

1-1-6 Echizenya Bld.7F, Kyobashi, Chuo-ku, Tokyo, 104-0031, Japan
TEL. +81-3-5205-6030 FAX. +81-3-5205-6035

Sapporo :

2-1-5 Regent Bld.3F, Kita2-jonishi, Chuo-ku Sapporo-shi,
Hokkaido, 060-0002, Japan
TEL. +81-11-223-5678 FAX. +81-11-223-5680

Nago :

1-3-6, Agarie, Nago-shi, Okinawa, 905-0021, Japan
TEL. +81-980-51-0616 FAX. +81-980-51-0628

Shin-Osaka :

4-1-45 Shin-Osaka Yachiyo Bld.1F, Miyahara, Yodogawa-ku Osaka-shi,
Osaka, 532-0003, Japan
TEL.+81-6-6152-5407 FAX. +81-6-6152-5408

Fukuoka :

1-2-5 il cassetto Bld.5F, Daimyo, Fukuoka Shi Chuo Ku, Fukuoka Ken,
810-0041, Japan
TEL.+81-92-741-4132 FAX. +81-92-741-4133

Osaka Factory :

1-40-1, Hoshidakita, Katano-shi, Osaka, 576-0017, Japan
TEL. +81-72-893-2290 FAX. +81-72-893-8007

Contents

<input type="checkbox"/> Important Safeguards	2-3
<input type="checkbox"/> Introduction	4
<input type="checkbox"/> Precautions on use of Strong Acidic and Acidic Waters as well as KANGEN Water	5
<input type="checkbox"/> Features	6
<input type="checkbox"/> Accessories	7
<input type="checkbox"/> Name of each parts	8-9
<input type="checkbox"/> Displays and Description on Operation panel	10
1 Preparations	11
· Selecting a Location	11
· Installing the Corporation Cock	12
· Installing the Main Unit	13
· About the power cable	14
2 Using the Unit	15
· Producing the KANGEN Water	15-16
· Producing Acidic Water	17
· Producing Strong Acidic Water/ Strong KANGEN Water	18-21
· Cleaning inside the sodium chloride tank and air discharge pipe	22
· Producing Purified Water	23
· Cleaning	24-25
3 Replacing the Water filter	26-27
4 Options	28
5 Safety Precautions	29-30
6 Troubleshooting Guide	31-32
7 Standard Specifications	33
8 After-sales Service	Back



Important Safeguards

● Read all instructions before using:

DANGER - To reduce the risk of electrocution:

1. Always unplug this product immediately after using.
2. Do not use while bathing.
3. Do not place or store product where it can fall or be pulled into a tub or sink.
4. Do not place in or drop into water or other liquid.
5. Do not reach for a product that has fallen into water. Unplug immediately.

WARNING - To reduce the risk of burns, electrocution, fire, or injury to persons.

1. A product should never be left unattended when plugged in.
2. Close supervision is necessary when this product is used by, on, or near children or invalids.
3. Use this product only for its intended use as described in this manual. attachments not recommended by the manufacturer.
4. Never operate this product if it has a damaged cord or plug, if it is not working properly, if it has been dropped or damaged, or dropped into water. Return the product to a service center for examination and repair.
5. Keep the cord away from heated surfaces.
6. Never use while sleeping or drowsy.
7. Never drop or insert any object into any opening or hose.
8. Do not use outdoors or operate where aerosol (spray) products are being used or where oxygen is being administered.
9. Connect this product to a properly grounded outlet only. See Grounding Instructions.

● Save these instructions:

- a) Instructions and caution statements for cleaning, user maintenance, operations recommended by the manufacturer, such as lubrication or nonlubrication, and a warning to the user that any other servicing should be performed by an authorized service representative or that the product has no user serviceable parts. The manual or other literature packaged with the product shall also indicate the product is for household use.
- b) In the case of product employing an automatically reset thermal limiter, that shuts off the entire product, instructions to the user on what to expect in the event the thermal limiter operates.
- c) Specific instructions for the proper method of cord storage, total product storage, and the like when the product is not in use; and for cord care while in use, such as for hand supported products, untwisting, and the like.
- d) In the case of a product intended to be used with water, additives, conditioners, or other solutions with or without water, or a product that relies on the conductivity of water for normal operation (electrode type product), and for which the use of baking soda, salt, or other substances to improve the conductivity of the water is stipulated, specific instructions on the proper liquid or additive to use and the exact amount to be used in conjunction with the product.

■ Grounding Instructions:

This product should be grounded. In the event of an electrical short circuit, grounding reduces the risk of electric shock by providing an escape wire for the electric current. This product is equipped with a cord having a grounding wire with a grounding plug. The plug must be plugged into an outlet that is properly installed and grounded.

DANGER - Improper use of the grounding plug can result in a risk of electric shock. If repair or replacement of the cord or plug is necessary, do not connect the grounding wire to either flat blade terminal. The wire with insulation having an outer surface that is green with or without yellow stripes is the grounding wire. Check with a qualified electrician or setviceman if the grounding instructions are not completely understood, or if in doubt as to whether the product is properly grounded.

Introduction

● Indicators used in this manual

The marks in this manual indicate areas of importance, and are explained below. Be sure to read the Warning and Caution instructions carefully

■ Level of danger



Indicates an imminently hazardous situation which may result in health hazards if the device is handled in a manner other than described in this manual.



Indicates a potentially hazardous situation which may result in minor or moderate injury if the device is handled in a manner other than described in this manual.

Description of signal marks

Mark	Title	Significance
	General	Used to indicate general precautions, warnings and dangers.
	General	Used to notify general prohibition precautions, warning and danger.
	General	Used to describe behavior of general users.
	Open flames	Used to warn against any behavior that could result, under certain conditions, in the unit catching fire as a result of proximity to flame.
	Prohibition of use at water splashing place, such as, bath or shower room.	Used to prohibit use of the product through using near baths or in showers, or any place where the unit may come in contact with water, the unit not being waterproof.
	Disassembly	Used to warn against self-repair or taking apart the unit by oneself, which could cause electric shock or other injuries.
	Unplugging	Used to indicate to the user when it is necessary to unplug the product, especially when it is showing signs of being damaged, or when a thunderstorm is expected.



- ※ All the precautions described here are classified as “⚠ Warning” and “⚠ Caution”. Any potential hazardous situation which could result in death or serious physical injury are referred to under the sign “⚠ Warning”. However, other potentially hazardous situations referred to under the sign of “⚠ Caution” can also present serious danger, depending on the case and situation. All the precautions, therefore, should be observed strictly.
- ※ We are not responsible for any damage to the product or accidents caused by improper use or by disregarding the precautions mentioned here.
- ※ After reading this manual, please keep it in a safe place for future reference.

Preparations on use of Strong Acidic and Acidic Waters as well as KANGEN Water

Warning - Please observe carefully for your own safety -

 Please observe	<ul style="list-style-type: none"> · If the following explanation describes your condition, please consult your physician before using Acidic or Strong Acidic Water. <ul style="list-style-type: none"> ■ Delicate skin ■ Allergies · If you experience any skin irritation after using any type of Acidic Water, consult your physician before continuing usage of this product. · Please take the following precautions prior to drinking KANGEN Water : <ul style="list-style-type: none"> ■ Do not take medication with KANGEN Water. ■ Do not take KANGEN Water if you are the trouble in kidney (kidney failure and trouble of potassium excretory process). ■ If you experience any discomfort or you see no improvement of your health condition, please stop using and consult your doctor. ■ If you are under a physician care, are the trouble of kidney or are experiencing physical abnormality, please consult your physician before using. ■ Do not use KANGEN Water with baby formula or baby foods .
---	--

Caution

 Prohibited	<ul style="list-style-type: none"> · Do not drink any of the following types of water; they may negatively affect your health. <ul style="list-style-type: none"> ■ Strong Acidic Water ■ Acidic Water ■ Cleaning water ■ Water containing pH test liquid ■ Strong KANGEN Water at the production of Strong Acidic Water ■ Water being discharged from the secondary water hose · When drinking KANGEN Water, adjust the pH value 9.5 or lower. Do not take more than the pH value 10.0 because of unsuitable for drinking. And do measuring regularly. · Please use KANGEN Water rapidly after generation. · Do not use KANGEN or Acidic Water in fish bowls or aquariums: changes in pH may kill fish. · Do to the fact that copper containers are acid-sensitive and aluminum containers are alkaline-sensitive that damaged, both should not be used.
 Please observe	<ul style="list-style-type: none"> · Use containers made of glass, plastic, ceramic, or other non-corrosive materials when storing Strong Acidic Water. Metal containers will corrode when in contact with Strong Acidic Water and should never be used. · Store Strong Acidic Water in a tightly sealed container that is incapable of light exposure. Use stored contents within one week. · Metal knives or spoons cleaned with Strong Acidic Water (Acidic Water) must be wiped or left to dry: Rust can develop if the utensils are left wet. · Store KANGEN Water in a sealed container and keep refrigerated. Use the contents within 3 days. · Pour water into the device for more than three minutes when you use the device first or when you use the new water filter. · Let the water flow for more than 10 seconds before your first use of the everyday. · If the unit has been unused for 2-3 days, let the water flow for more than 30 seconds. · Please execute that the disposal of expendable supplies and unused apparatus observe the regulations of the region.

Features

With just one touch of a button, you can produce five types of water: Strong Acidic Water, KANGEN Water, Acidic Water, Clean Water, and Strong KANGEN Water. You can use the different water according to the intended applications.

Producing Strong Acidic Water

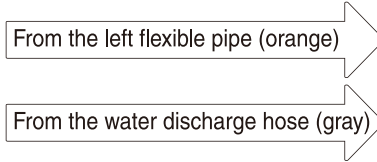
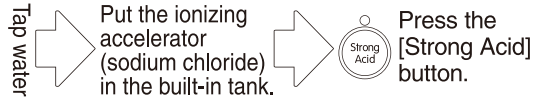

Strong Acidic Water is produced.
Strong KANGEN Water is produced.

Inadequate for drinking.

Producing KANGEN Water

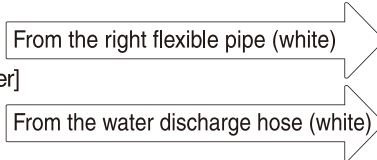
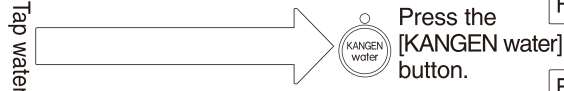

KANGEN Water is produced. (for drinking)
(Acidic Water is produced.)

Inadequate for drinking.

Producing Acidic Water

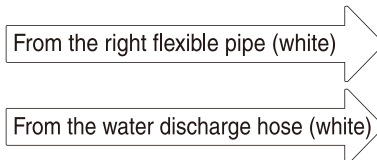
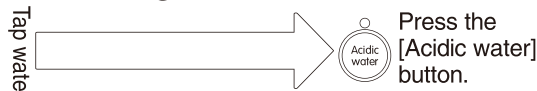

Acidic Water is produced.
(KANGEN Water is produced.)





Inadequate for drinking.

Producing Purified Water



Purified Water is produced. (for drinking)

5 types of water, subdivided into 6 according to pH, are available to suit your specific need.

MODE	pH LEVEL	USE	CAUTION
KANGEN water	pH9.5	Making herb tea, mild herb tea Most suitable for making barley water or oolong tea. Mild barley water can be made in half the time it would take with ordinary water.	Not to be used with medicine. When taking medicine, select the purified water mode. 
	pH9.0	Making green tea or coffee and cooking rice Your green tea or coffee will taste mellow, and your rice will cook soft and full. Most suitable for your healthy diet.	
	pH8.5	Maintaining your health This is pH level is recommended for people to get used to KANGEN Water.	
Purified water	pH7.0	To be taken with medicine or added to powered baby milk This neutral water can be used as water to be taken with medicine as well as water you can drink every day.	
Acidic water	pH6.0	For your skin care To be used as astringent water, bath water, or after-shave astringent water.	
Strong Acidic	pH2.5	To be used as disinfectant or cleaning This water washes clean your kitchen utensils as cooking knives, cooking boards, and washes cups and saucers stain-free. It also destroys pathogenic bacteria from fruit.	NOT FOR DRINKING 
Strong KANGEN	pH11.0	Has the power to dissolve toughstains Use the added power of Strong KANGEN Water to remove tough Kitchen grease stains or cleaning floor. Use to wash fish, meat, and vegetables.	

Warning You are requested to observe

Make sure that sufficient ventilation is provided to let out harmful gases that result from Strong Acidic Water. In the worst possible case, your life would be at risk if the gases filling your room has no way out at all.



Accessories

■ Check that the following accessories are included in the package.

About installation

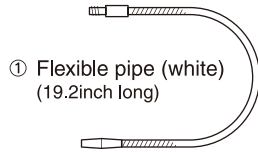

① Flexible pipe (white)
(19.2inch long)

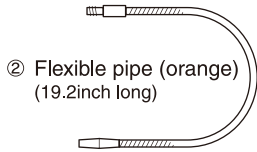

② Flexible pipe (orange)
(19.2inch long)

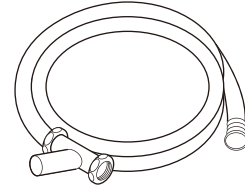

③ Water supply hose with strainer

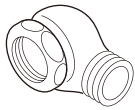

④ Diverter with nut

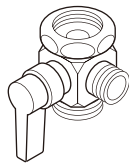

⑤ Corporation cock

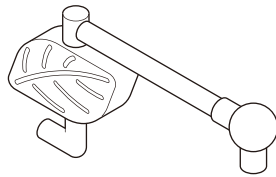

⑥ Secondary acidic water stand
(with suction pad)

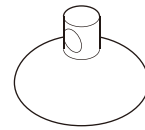

⑦ Ø12 Suction pad (1 pc.)

About the usage

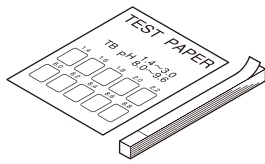

⑧ Book pH test paper

⑨ pH test kit

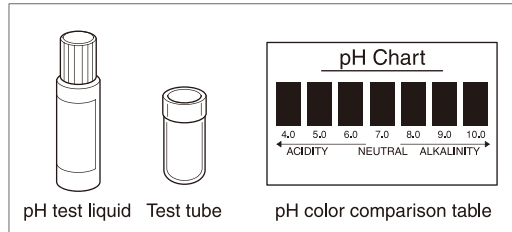

pH test liquid

Test tube

pH color comparison table



⑩ Wash bottle



⑪ Measuring cup

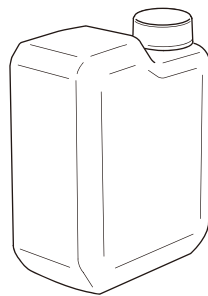

⑫ 0.52gal. polyethylene tank

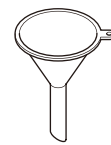

⑬ Funnel

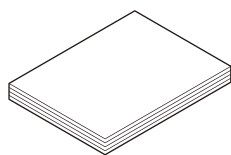

⑭ Operation manual

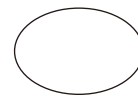

⑮ Water filter change label

Name of each parts

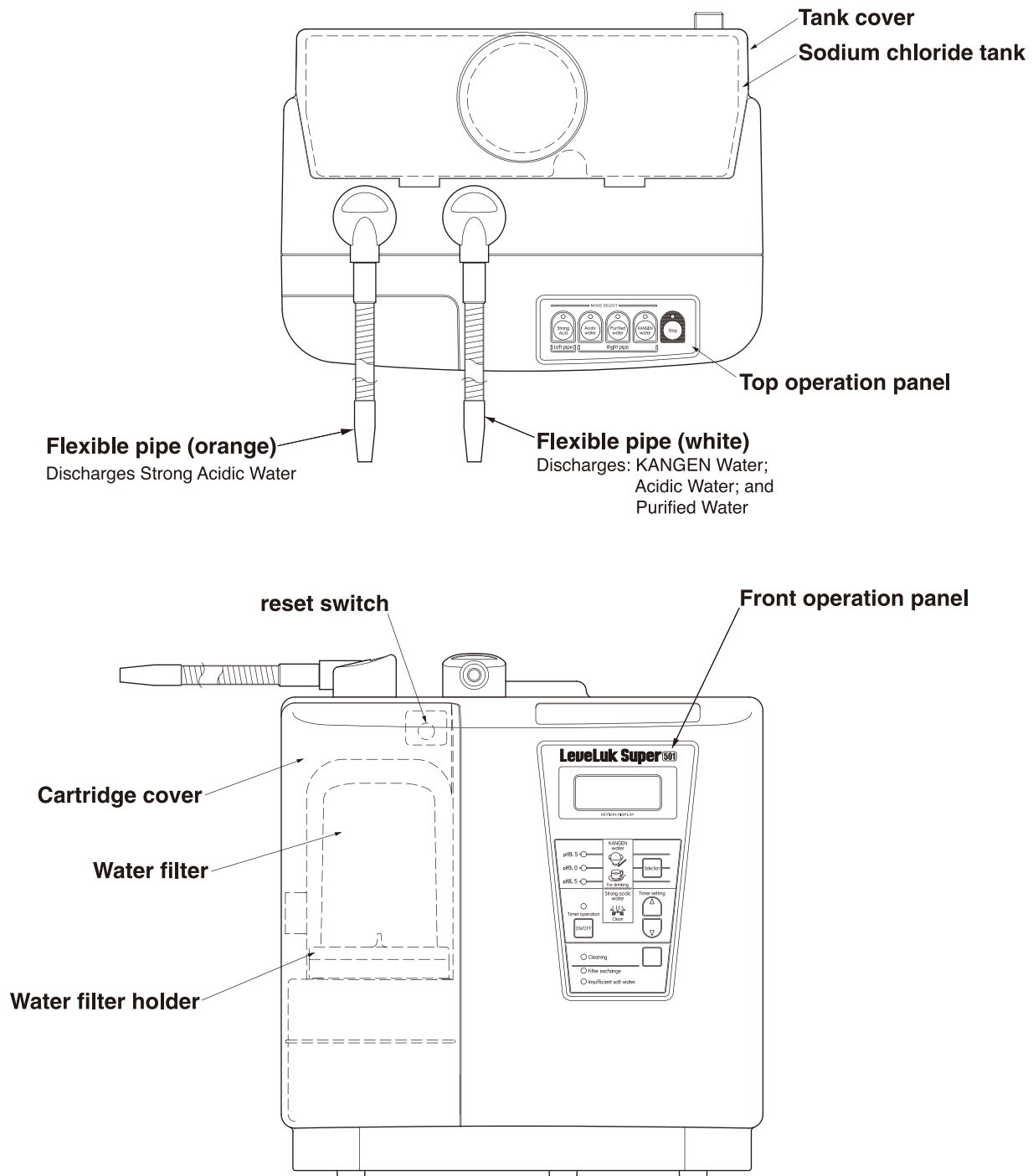

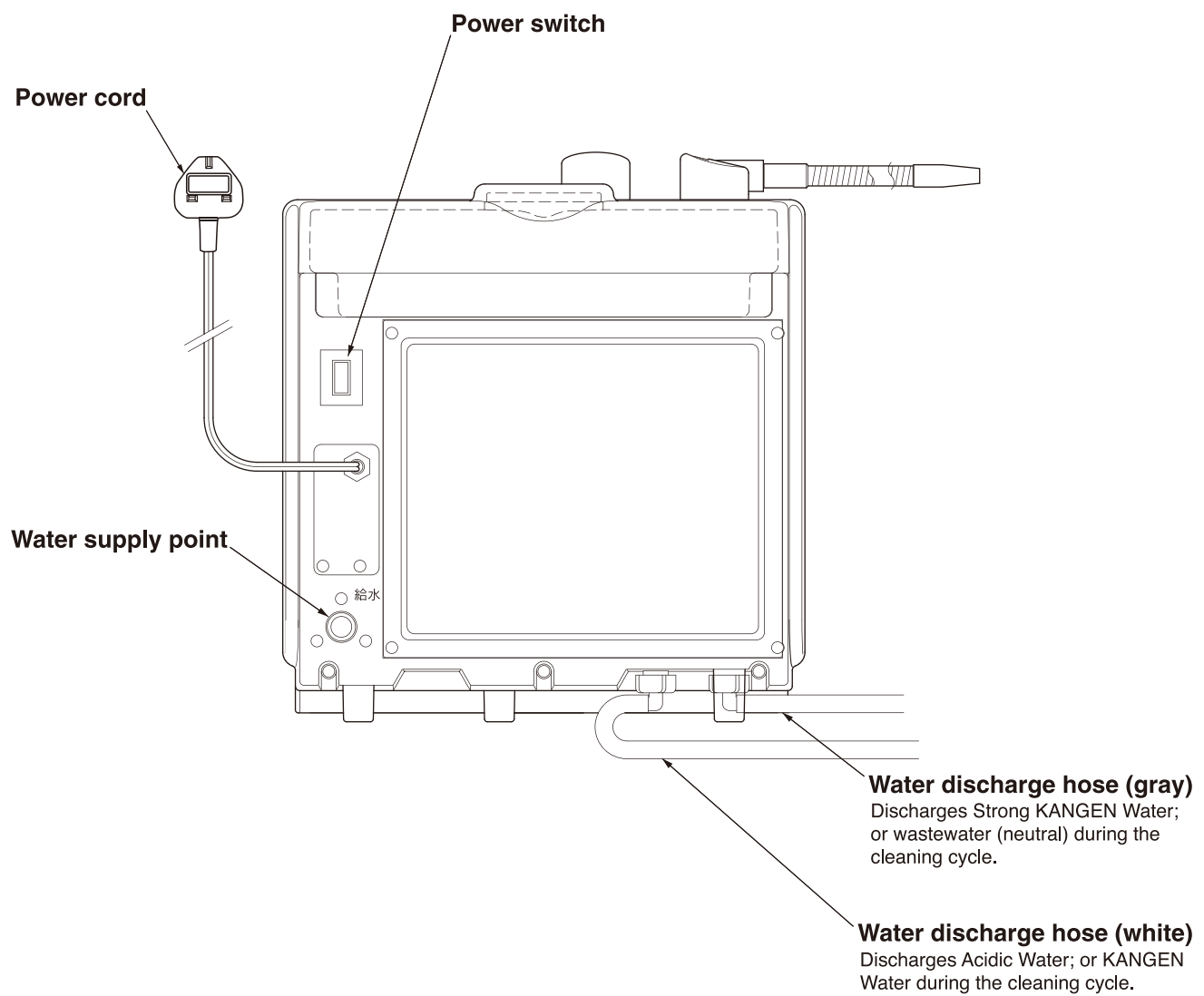

⚠ Attention

For connection to water mains, the detachable new hose-sets supplied with the appliance are to be used and that old hose-sets are not to be reused.

Displays and Description on Operation Panel

Operation Panel within Cover

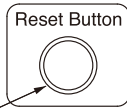

Filter Reset Button

Press this button for replacing the filter. The filter replacement lamp will go out.

Strong Acidic Water Generation Button

Strong Acidic Water is discharged from the upper left flexible pipe (orange). Strong KANGEN Water is discharged from the lower hose (gray).

Acidic Water Generation Button

Acidic Water is discharged from the upper right flexible pipe (white).

Purified Water Generation Button

Purified Water is discharged from the upper right flexible pipe (white).

KANGEN Water Generation Button

KANGEN Water is discharged from the upper right flexible pipe (white).

Stop Button

Use this button to stop the generation operation or to reset after an error.

Top Operation Panel

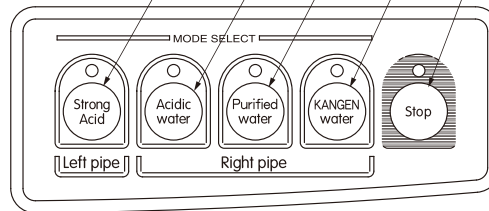

LCD Display

Displays the current operation status.

Front Operation Panel

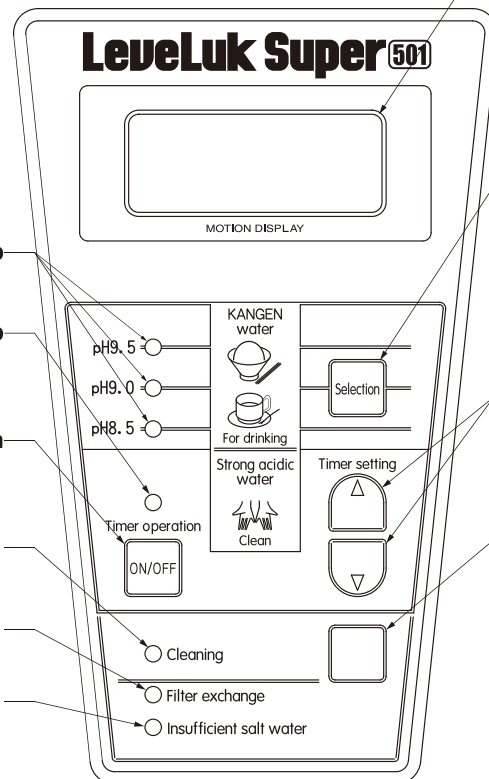

KANGEN Water pH Lamp

Strong Acidic Water Timer Mode Lamp

Displays the automatic stop mode during the Strong Acidic Water generation cycle.

Strong Acidic Water Timer On/OFF Button

Switches the mode to the automatic stop mode during the Strong Acidic Water generation cycle.

Cleaning Lamp

Illuminates during the cleaning operation cycle.

Purified Water Filter Service Life Lamp

Notifies when it's time to replace the filter.

Sodium chloride Level Warning Lamp

Illuminates when the level of ionizing accelerator (sodium chloride) in the sodium chloride tank is too low during the Strong Acidic Water generation process.

KANGEN Water pH Selection Button

Use this button to select the pH value of KANGEN Water.

Strong Acidic Water Timer Set Buttons

You can set the Strong Acidic Water timer in a range from 1 to 30 minutes. (The button is enabled only when the timer is on.)

Manual Cleaning Button

Usually, the automatic cleaning function works effectively. However, in areas where the hardness of water is high, use this switch from time to time to clean the unit.

1 Preparations

- 1 Selecting a location

Warning **Prohibited**

- Do not install in a closed small room as chlorine gas that results from electrolysis is highly toxic.

Warning **You are requested to observe**

- The heavy weight of this product and the chemicals it produces requires that the following cautions be talked:
 - * Accidental tippage that injures humans or damages the product and other objects around it
 - * Poisoning due to the gases given off during operation
- Inadequate discharge piping can cause failure or water leak. Please take the following precautions when laying piping.

Caution **You are requested to observe**

- Do not place anything on the water processor body, otherwise, machine trouble or falling may result.
- Do not close the discharge hose opening. (failure can cause water leak or electrolytic error)
- Check the discharge hose to see if it is twisted or bent. (failure can cause water leak or electrolytic error)
- Keep the secondary hose level lower than the level of the water processor body. Otherwise, the water in the processor body will remain.

■ Secure the installation location of the main unit.

● Dimensions of the Main Unit

- The distance between the main unit and the water faucet should be less than 2 m. (If the distance is greater than 2 m, an optional extension hose is required.)
- The main unit should be located within 2 m of the wall socket. (If the wall socket is located beyond that distance, use an extension cord.)
- The water discharge hoses (white and gray) and the flexible pipes should be extending over the kitchen sink. (A long flexible pipe and extension hoses (gray and white) are available as options.)
- It is recommended that the level difference between the flexible pipe and water discharge hose spouts should be within 50 cm.

■ Install in at the following place

<ul style="list-style-type: none"> In a well ventilated area. 	<ul style="list-style-type: none"> An area away from flammable objects. In an area with room temperature between 5 to 40°C. 	<ul style="list-style-type: none"> On a flat stable counter top area capable of supporting the weight of the machine. Do not install under the sink.
<ul style="list-style-type: none"> An area not exposed to direct sunlight, wind or rain. 	<ul style="list-style-type: none"> An area free from splashing water, steam, chemicals and dust. 	

1-2 Installing the Corporation Cock

- In case of a general type of faucet and the mixing faucet (installation is feasible by using the standard accessory.)

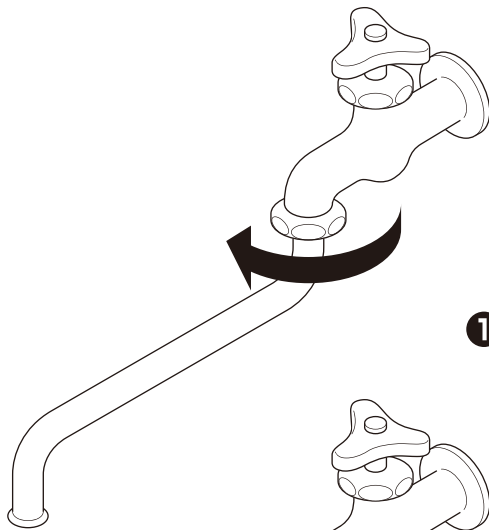

- 1 Remove the hexagonal cap nut from the water faucet using a wrench or the like.

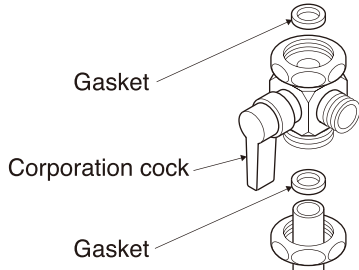
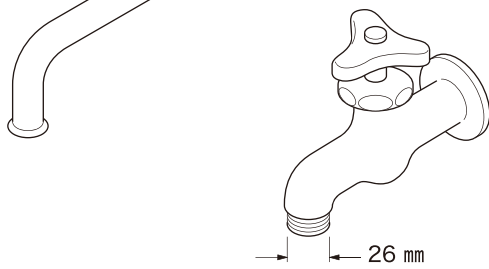
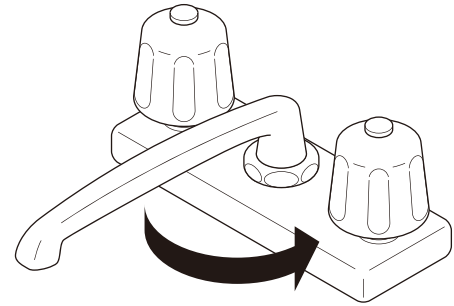

- 2 After installing the corporation cock on the water faucet, mount the water faucet pipe on the cock. At this time, do not forget to mount the rubber gaskets that were originally used.

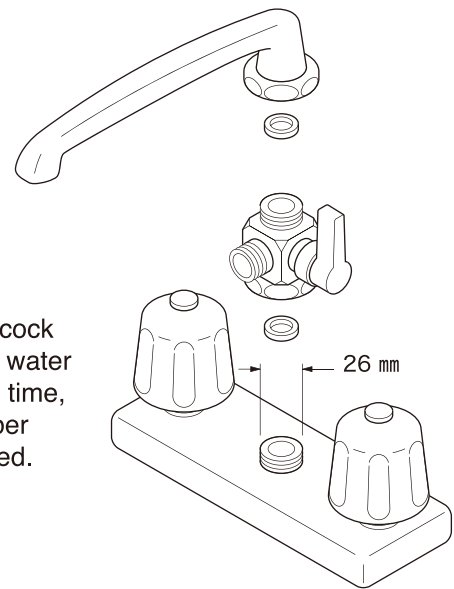

- 3 Installation completion.

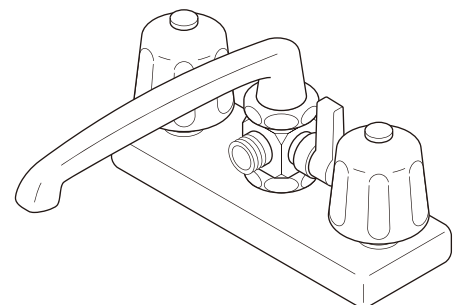

1 - 3 Installing the Main Unit

5 Plug in the power cord.

1 Mount the flexible pipes (white and orange).

Left: Orange

Right: White

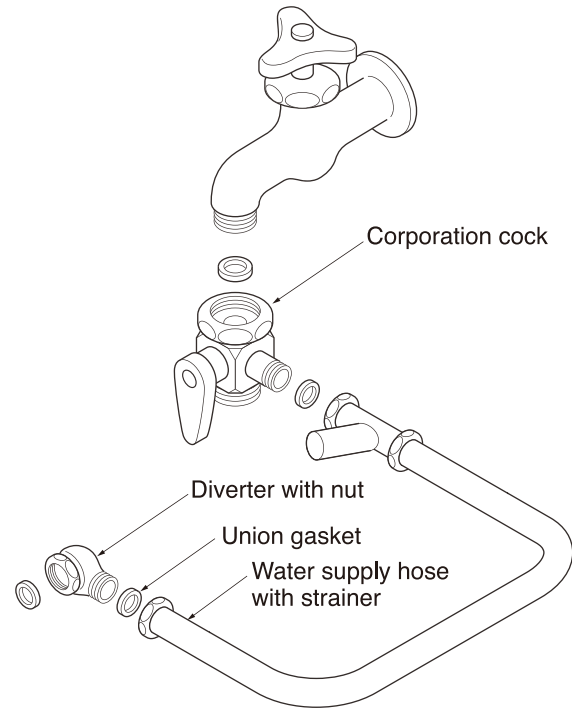

4 Connect the diverter with the nut, water supply hose with strainer, and corporation cock, in that order, to the water supply point on the back of the main unit while inserting a union gasket between the respective connections. Then, connect the cock to the water faucet or water pipe.

6 Turn on the Power switch provided on the back of the main unit.

2 Connect the spout stand and water discharge hose (gray), and fix the stand with the suction pad.

Discharging water identification seal (orange)

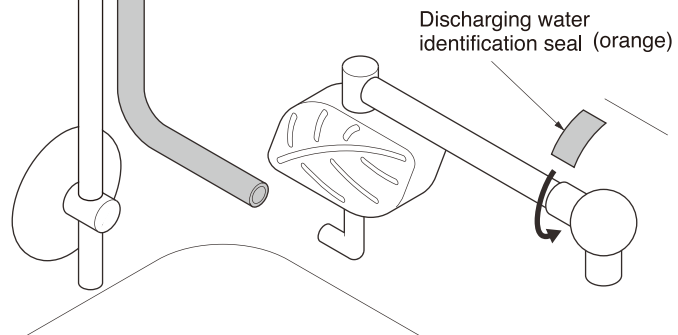

3 Fix the water discharge hose (white) with the suction pad. When you use Acidic Water that is produced in the KANGEN Water generation cycle, apply the discharging water identification seal (white) on the spout stand.

IMPORTANT NOTE :

The original parts used for Enagic products are designed to provide functionality and safety. For this reason, ENAGIC does not approve the use of aftermarket or imitation products. In particular, installing any product other than the SD-U under the sink is strictly prohibited.

Parts Warranty :

Enagic warranty does not cover damages or failure of its products when used with third party products. ENAGIC is not responsible for failure, accident or damage resulting from the use or modification of parts other than genuine ENAGIC parts.

1 - 4 About the power cable



● Please use the outlet of AC 220 - 240 V , 50 - 60 Hz power.

* Using improper voltage will void the warranty.

Warning

 Prohibited	<ul style="list-style-type: none">• Never bend, pull, twist, or bundle the power cord. Do not lay heavy objects on top of the cord or clamp the cord: This may damage the cord, and cause electric shock that may lead to hazardous fire.• Do not use a damaged power cord or loosely fitted one. It may cause electric shock, short circuit or fire.• Stapling the power cord is strictly prohibited. This will cause irreparable damages to the cord and possibly fire.• Do not plug too many plugs into one outlet.• When cleaning the outlet, first disconnect the power plug. Dust on outlets can cause fire.• Connect or disconnect the power plug by holding the plug instead of the cord. Pulling the cord can cause breakage, fire, and/or electric shock.• Use only the proper power supply/ voltage. Using improper power source/voltage can cause fire or electric shock.
---	---

Caution

 Please observe	<ul style="list-style-type: none">• Insert the power plug firmly. If the plug and connector is not inserted properly, electric shock or a fire caused by heat generation may result.• Be sure to check that all buttons work properly.• Please bundle the cord during storage to avoid damage.• If the supply cord is damaged, it must be replaced by the manufacturer, its service agent or similarly qualified persons in order to avoid hazard.
	<ul style="list-style-type: none">• A wet plug can cause electric shock. If the power plug is severely wet<ol style="list-style-type: none">(1) Disconnect the plug from the outlet(2) Wipe the water off the plugs(3) Consult your local dealer for repairs• Never handle power plugs with wet hands. If power plug is wet, first disconnect it completely from the outlet and wipe it dry. Failure to follow these procedures may result in electric shock.• Always unplug this product after use.

2 Using the Unit

- 1 Producing the KANGEN Water

⚠ Caution Do not use KANGEN Water for taking medicinal products.

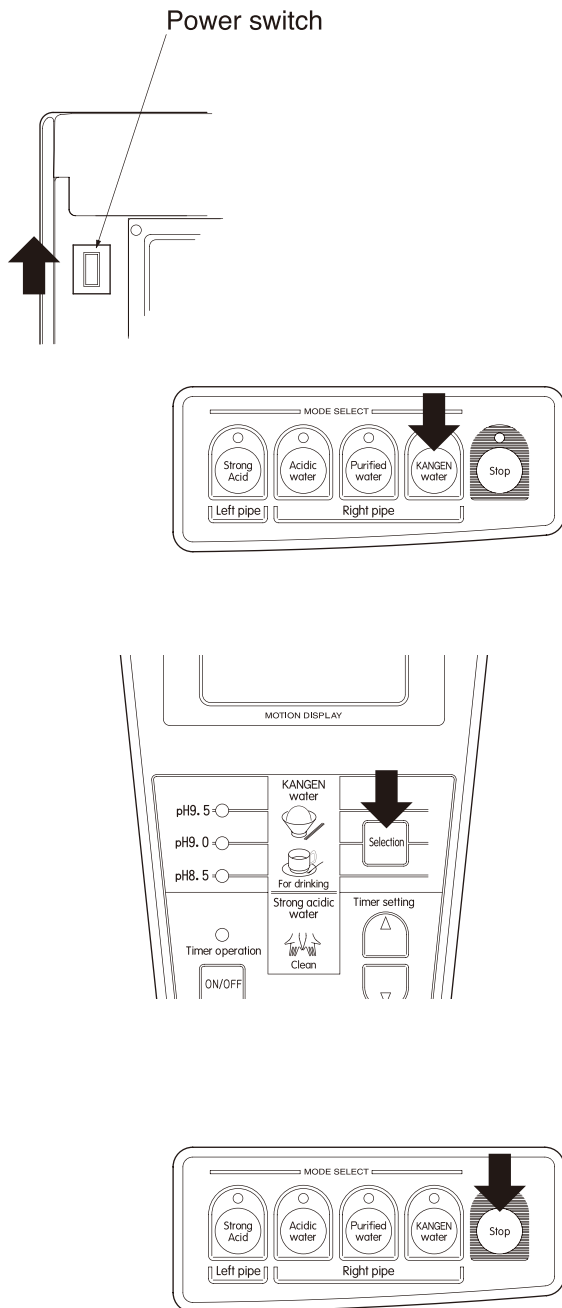

1 Turn on the Power switch provided on the back of the main unit.

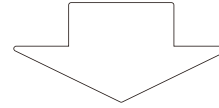

2 Press the [KANGEN Water] button on the top operation panel of the main unit. KANGEN Water will be discharged from the right flexible pipe (white). (From the water discharge hose (white), Acidic Water will be discharged.)

LCD Display

KANGEN
>>>>

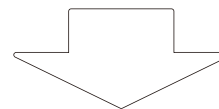

3 Press the [Selection] button on the front operation panel, and set the KANGEN Water mode to either pH8.5, pH9.0, or pH9.5. (The default setting is pH8.5) The mode is retained once selected, and water generation is initiated the next time and thereafter under the same mode.

* The pH values will fluctuate depending on the quality and pressure of water in your area.

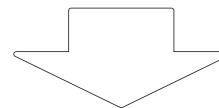

4 Press the [Stop] button on the top operation panel. Discharging of KANGEN Water from the right flexible pipe (white) and Acidic Water from the water discharge hose (white) will stop, and the LCD display goes off.

⚠ Caution

- Do not use the first one or two glasses of water processed that day, as that water may be remaining from the previous day.
- Should the first water come out cloudy, this does not represent a machine failure, but is rather extra activated charcoal running out of the machine. Simply wait until the water comes out clear.

⚠ Caution **!** You are requested to observe

- Addition of glycerophosphoric acid calcium must be conducted after stopping the unit.

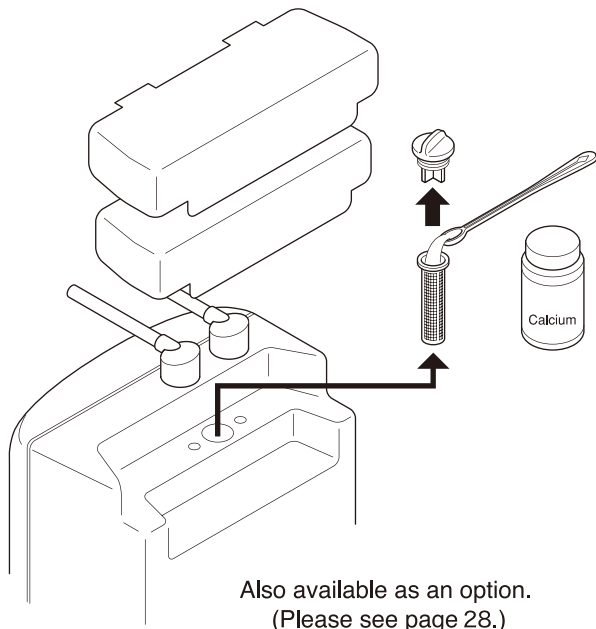

Also available as an option.
(Please see page 28.)

- 1 Detach the tank cover and tank at the upper part of the backside of the main unit.
- 2 Rotate the cap of the calcium charging port located underneath the sodium chloride tank counter-clockwise and detach. Apply approximately 2g of glycerophosphoric acid calcium to the adding cylinder attached to the cap (fill up to 80% of the cylinder).
- 3 Set the cylinder onto the cap. Fully screw in the cap to the main unit by rotating it clockwise, and set the tank and the tank cover in the original positions.

- 4 Produce KANGEN Water using the same operation procedures as described in Steps 1 to 4 of the section Producing KANGEN Water.

⚠ Caution

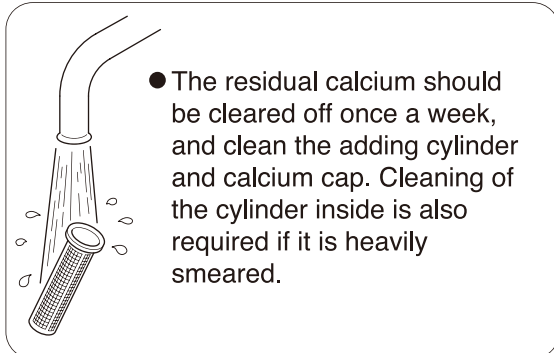

- The residual calcium should be cleared off once a week, and clean the adding cylinder and calcium cap. Cleaning of the cylinder inside is also required if it is heavily smeared.

⚠ Caution

- Calcium glycerophosphoric acid calcium (included) increases the calcium concentration in the KANGEN Water.
- The pH concentration also increases. So, set the Select button to the pH value you require.

How to measure pH value in KANGEN Water

■ pH test liquid set

- Measure the pH value in the KANGEN Water thus processed using the pH test liquid (attached).

Optimum pH

Potable range
pH8.5 ~ 9.5

- 1 Put KANGEN Water in the attached test tube in about 2cm deep.
 - The pH value is unsteady in the water that is processed initially. Flow the water for 10 sec. or more before sampling.

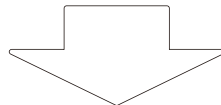

- 2 Add about 1-2 drops of test liquid in the tube and shake the content well.

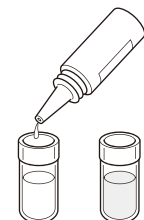
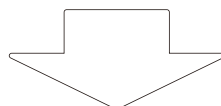

- 3 Compare the color of the water in the test tube with that of the color comparison paper and check the pH concentration.
 - Do not drink the water in the test tube after testing.
 - Keep the testing liquid in a cold and dark place.
 - Store the testing liquid out of children's reach.

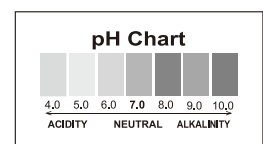

2-2 Producing Acidic Water

⚠ Caution Inadequate for drinking.

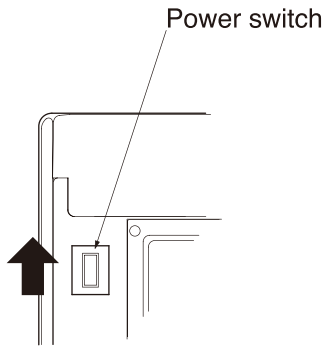

- 1 Turn on the Power switch located on the back of the main unit.

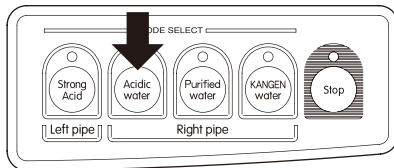
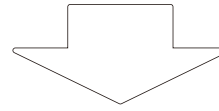

- 2 Press the [Acidic Water] button located on the top operation panel of the main unit. Acidic Water will be discharged from the right flexible pipe (white). [KANGEN Water will be discharged from the water discharge hose (white).]

LCD Display
BEAUTY
>>>>
Beep, beep, beep

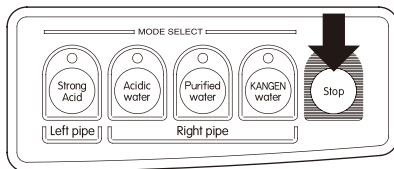
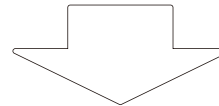

- 3 Press the [Stop] button on the top operation panel. Discharging of Acidic Water from the right flexible pipe (white) and KANGEN Water from the water discharge hose (white) will stop, and the LCD display goes off.

2 - 3 Producing Strong Acidic Water/Strong KANGEN Water

⚠ Caution

- When producing Strong Acidic Water or Strong KANGEN Water, check that the built-in tank is filled with the ionizing accelerator (sodium chloride). (Check that the [Low Saltwater Level lamp] does not illuminate or is not blinking before producing Strong Acidic Water or Strong KANGEN Water.)
- The unit will stop operation approximately 1 minute and 30 seconds after the [Low Saltwater Level] lamp starts blinking.

⚠ Caution

[Precautions on the ionizing accelerator (salt)]

- For the ionizing accelerator, be sure to use salt (table salt commercially available, etc.) (containing 99% or more sodium chloride). Use of agents other than salt may cause deteriorated unit performance or damage the unit.

Do not use the following salts:

- Calcium-mixed Salt (calcium citrate, calcium carbonate, etc.)
Calcium will deposit in the unit, which deteriorates electrolysis performance.
- Seasoning (amino acid)-mixed Salt
The ORP value of Strong Acidic Water will deteriorate.
- Crude Salt and Raw Salt
Impurities may damage the unit.

⚠ Caution

When producing Strong Acidic Water or Strong KANGEN Water, be sure to put the ionizing accelerator (sodium chloride) in the built-in tank.

1. Preparing the ionizing accelerator (sodium chloride)

- 1 Prepare 225cc of salt (approx.300g) by measuring it with the measuring cup that comes with the unit.

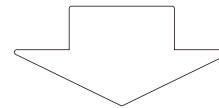

- 2 Put the measured salt from step 1 in the tank (2 liters) that comes with the unit, and fill the tank with tap water up to the level marked on the tank. Cap the tank, and stir the solution until the salt is completely dissolved.

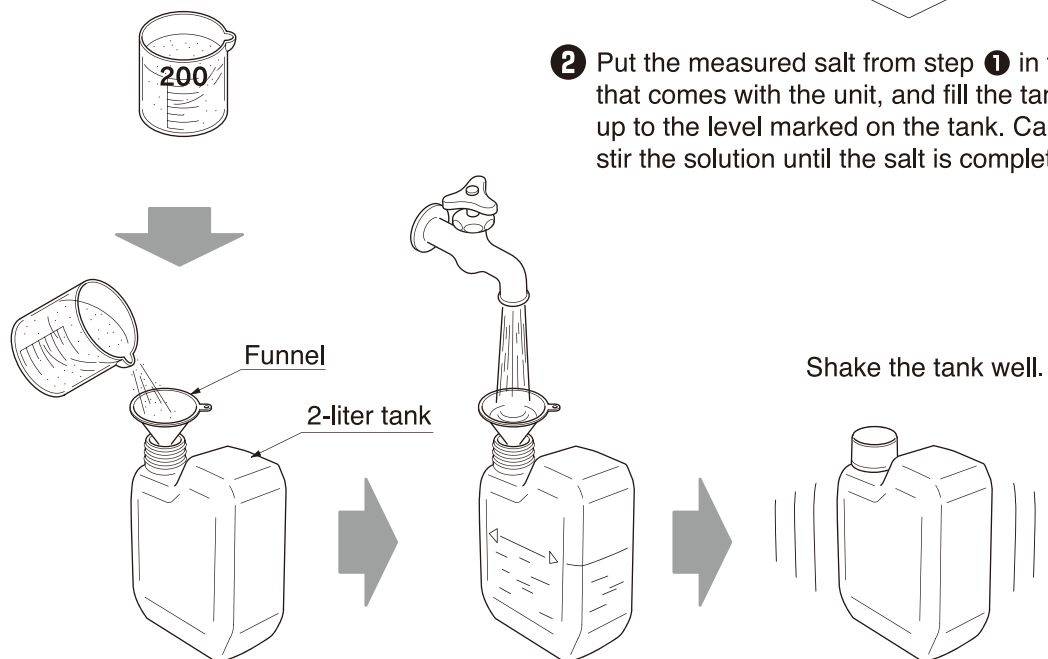

2. Put the ionizing accelerator (sodium chloride) in the built-in tank.

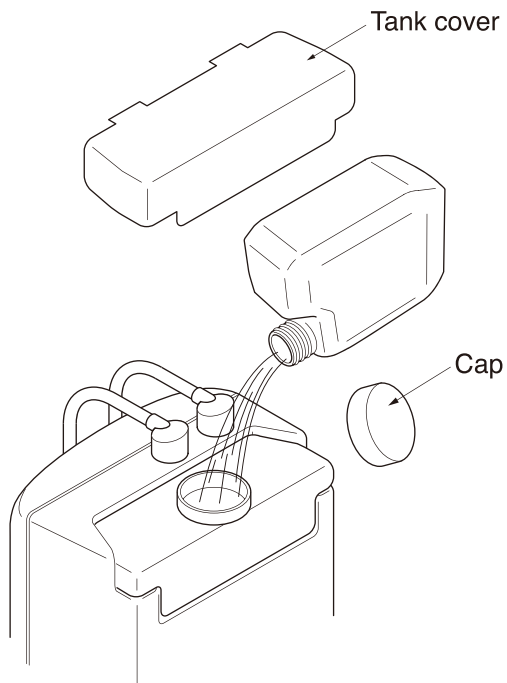

❶ Detach the tank cover located at the upper part of the back of the main unit.

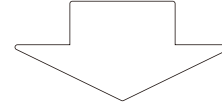

❷ Unscrew the cap to the tank, and put the sodium chloride prepared in the earlier step.

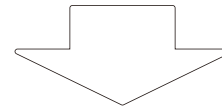

❸ Cap the tank.

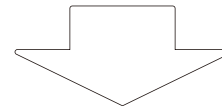

❹ Mount the tank cover.

⚠ Caution

- Be sure to completely dissolve the agent in water.
- Be sure to observe the specified salt concentration (approx. 20%).
- Do not spill the solution in the unit, since leakage of the ionizing accelerator may cause unit failures. If the solution is spilled, immediately wipe it off.
- If the tank is not supposed to be used for a long period of time, clean the inside of the tank with water.

■ Producing Strong Acidic Water

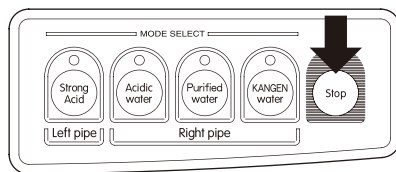
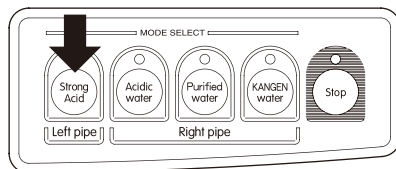
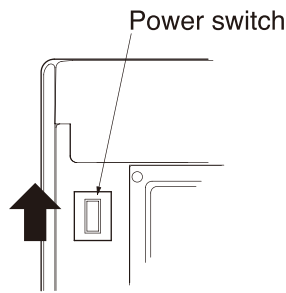

- 1 Set the Power switch on the back of the main unit to the [ON] position.

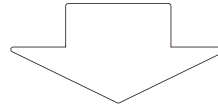

- 2 Press the [Strong Acidic Water] button located on the top operation panel. Strong Acidic Water will be discharged from the left flexible pipe (orange). [Strong KANGEN Water will be discharged from the water discharge hose (gray).]

LCD Display

STRONG

>>>>

Beep, beep, beep

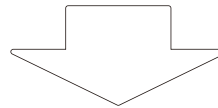

- 3 Press the [Stop] button on the top operation panel. Discharging of Strong Acidic Water from the left flexible pipe (orange) and Strong KANGEN Water from the water discharge hose (gray) will stop, and the LCD display goes off.

How to measure pH in Strong Acidic Water.

- Book pH test paper (attached) will be used.

■ Use pH test paper (included).

- 1 Carefully dip the pH test paper in the water sample (less than half a second). Then take out immediately.

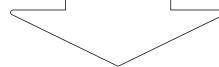

- 2 Shake the pH test paper gently to remove excess water.

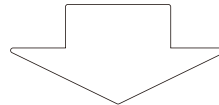

- 3 Check the color of the wet portion of the paper against standard color chart.

※ Color comparison and determination must be done in a brightly lit place.

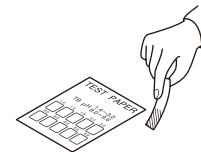

⚠ Caution ! You are requested to observe

- The pH test liquid (red) can not measure the pH value down to 4.0. For measuring the pH value of Strong Acidic Water, use the pH test paper, which can measure pH value lower than 3.
- The pH test paper can only be used to check pH value of Strong Acidic Water.
- Do not lick pH paper. If you do, wash out your mouth and gargle immediately.
- Dipping the test paper too long (longer than 0.5 sec) causes the pigment to be dissolved into the sample water, resulting in inaccurate test results.
- Leaving the pH test paper too long once it is removed from the sample water allows water..., and may result in inaccurate results.
- The sample water must be kept at room temperature to prevent pigment from diffusing too rapidly, as it would at high temperatures.
- The pH test paper may look different depending on storage conditions. This will not affect any of its properties or abilities.
- The pH test paper must be kept cool and dry in a dark place.

■ Producing Strong Acidic Water/Strong KANGEN Water

● Timer Function (Enabled only when producing Strong Acidic Water/Strong KANGEN Water.)

With the timer function, you can set the operation time in a range from 1 to 30 minutes. The operation automatically stops according to the time setting adjusted to the capacity of the Strong Acidic Water container.

Operating the Timer

- 1 Set the timer while the unit is stopped.

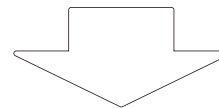
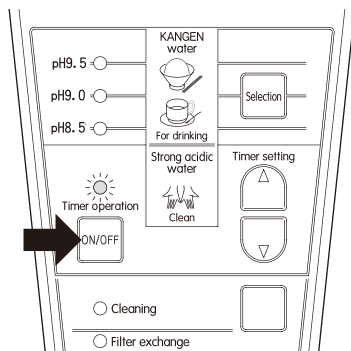

- 2 Press the [Timer Operation.] button on the front operation panel. The timer lamp will illuminate to indicate the set time (default value: 5 minutes) on the liquid crystal panel, and the timer mode is enabled.

LCD Display

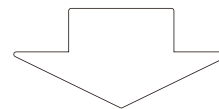
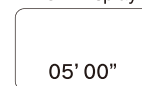

- 3 Set the operation time by using the [Timer Setting] button on the front operation panel. You can set the time in 1-minute increments in a range from 1 to 30 minutes.

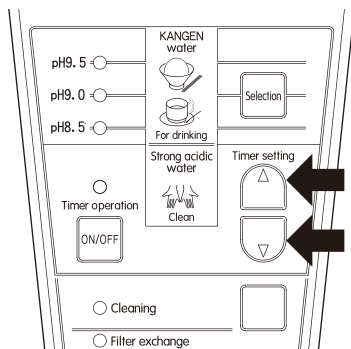

LCD Display

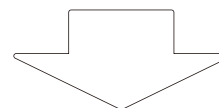

- 4 Press the [Strong Acid] button on the top operation panel. Generation of Strong Acidic Water/Strong KANGEN Water is initiated, and the liquid crystal panel displays the remaining operation time. When the indicated time reaches zero (0), the unit will stop. When you leave the unit under this status, the panel illumination will go off in about three minutes. (The [Timer Operation.] lamp stays lit.)

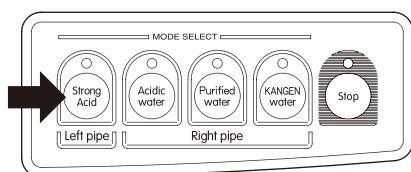

LCD Display



⚠ Caution

- For storing Strong Acidic Water, cleaning water will be discharged in full from the lower hose (gray). For storing Strong KANGEN Water, the cleaning water will be mixed. However, this does not affect the water quality.

Cleaning inside the sodium chloride tank and air discharge pipe

- When you do not produce Strong Acidic Water with the LeveLuk Super 501 for a long period of time (one week or longer), we recommend that you detach the sodium chloride tank and clean it with water.
- Since the unit uses high concentrations of sodium chloride water, the quantity of sodium chloride in the tank may not be correctly measured due to the collection of crystallized sodium chloride in the tank.

● For the best condition:

Execute the following once every several months

- Detach the sodium chloride tank. Alternatively, operate the unit under the Strong Acidic Water Mode until the sodium chloride water in the tank is used up and the unit automatically stops operation.
- While the unit is stopped, feed 20–50 cc of tap water from the accompanying wash bottle through the air discharge pipe located at the upper part of the unit to clean the crystallized sodium chloride in the hose.

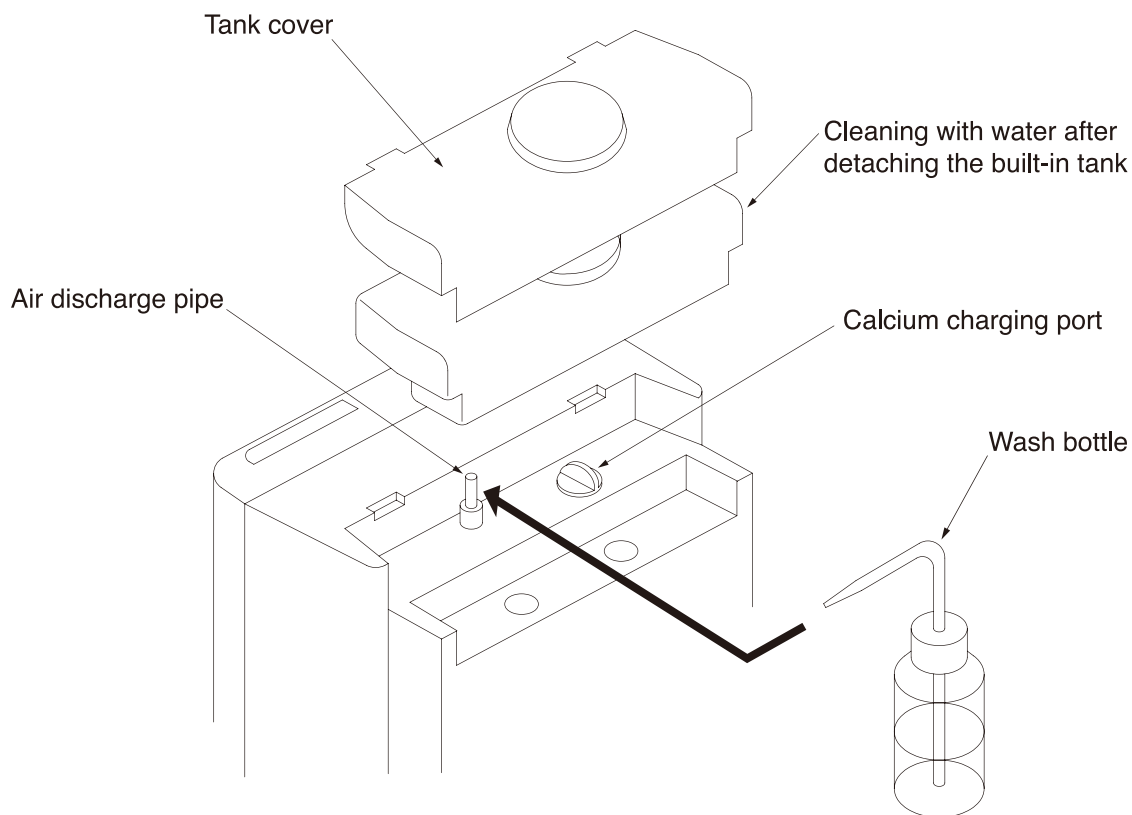

2 - 4 Producing Purified Water

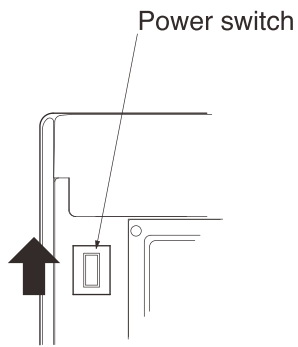

- 1 Set the Power switch on the back of the main unit to the [ON] position.

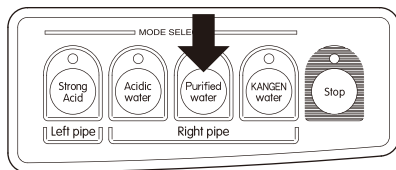
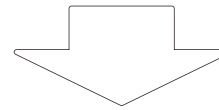

- 2 Press the [Purified Water] button (central button) on the top operation panel. Purified Water will be discharged from the right flexible pipe (white).

* Purified Water is also discharged from the lower hose (white). Do not use this water for drinking.

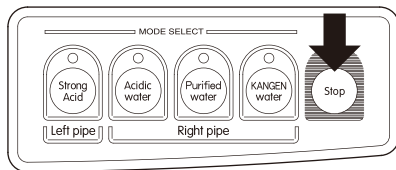
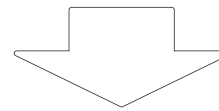
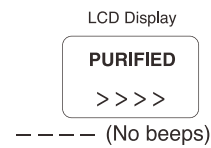

- 3 Press the [Stop] button. Discharging of Purified Water from the right flexible pipe (white) will stop, and the LCD display goes off.

⚠ Caution

- Do not use the first one or two glasses of water processed that day, as that water may be remaining from the previous day.
- Should the first water come out cloudy, this does not represent a machine failure, but is rather extra activated charcoal running out of the machine. Simply wait until the water comes out clear.

2 - 5 Cleaning

Caution

- Do not use the cleaning water for drinking.
- In the cleaning cycle while in the Strong Acidic Water generation process, all water is discharged from the lower discharge hose. [No discharge is made from the left flexible pipe (orange).]
- With the unit, two ionizing cells for producing KANGEN Water/Acidic Water and for producing Strong Acidic Water are cleaned independently. Therefore, the cleaning cycle may appear to be too short.
- When the [Stop] button is pressed during the cleaning cycle, cleaning will be resumed for the remaining time when the operation in the same generation mode is initiated next time.
- Switching of a mode to another mode during the cleaning cycle, the operation is continued under the switched mode. Cleaning will be resumed for the remaining time when the operation in the same generation mode is initiated next time.

■ Automatic Cleaning

- Calcium deposited on the electrode during electrolysis can cause degraded water producing performance. This unit automatically cleans the tank.
- When the total time for producing KANGEN Water or Acidic Water reaches 15 minutes, the unit cleans itself for about 30 seconds. It will then return to normal use.

LCD Display

CLEANING

>>>>

Beep, beep

Manual Cleaning

⚠ Caution

- In some areas, since the hardness of the original tap water is high (more calcium), the automatic cleaning described above results in insufficient cleaning.

Manual Cleaning under the KANGEN Water mode

While in the KANGEN Water production cycle (pH8.5/pH9.0/pH9.5), press the [Cleaning] button on the front operation panel of the main unit.

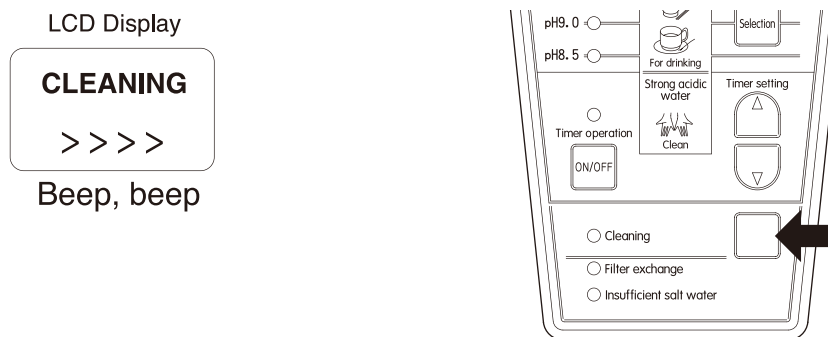

The cleaning operation is initiated for approx. 30 seconds, and KANGEN Water production is initiated under the same mode.

Manual Cleaning under the Purified Water Mode

Under the Purified Water mode, switching to the cleaning mode is not possible.

Manual Cleaning under the Acidic Water Mode

In the Acidic Water production cycle, press the [Cleaning] button.

The cleaning operation is initiated for approx. 30 seconds, and the Acidic Water production is resumed.

Manual Cleaning under the Strong Acidic Water Mode

In the Strong Acidic Water production cycle, press the [Cleaning] button.

The cleaning operation is initiated for approx. 30 seconds, and Strong Acidic Water production is resumed.

⚠ Caution

- While in the cleaning operation under the Strong Acidic Water mode, no discharging is made from the upper left flexible pipe (orange).

3 Replacing the water filter

■ **The water filter is a standard accessory that comes with a new unit.**
(Replacement activated charcoal water filters are available. Contact your local dealer.)

⚠ Caution **!** You are requested to observe

- Filter replacement must be performed with the faucet closed.

The timing for Water filter replacement is indicated by the illumination of the filter replacement lamp on the front operation panel.

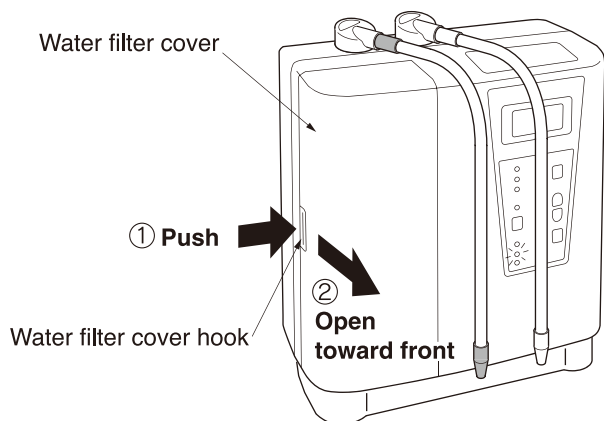
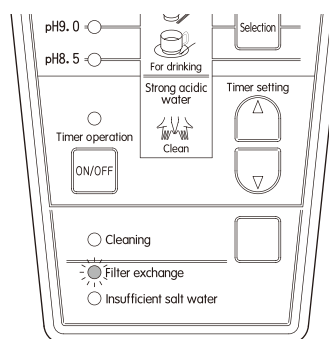

- 1 Push the water filter cover hook on the left side of the unit, and open and remove the cover.

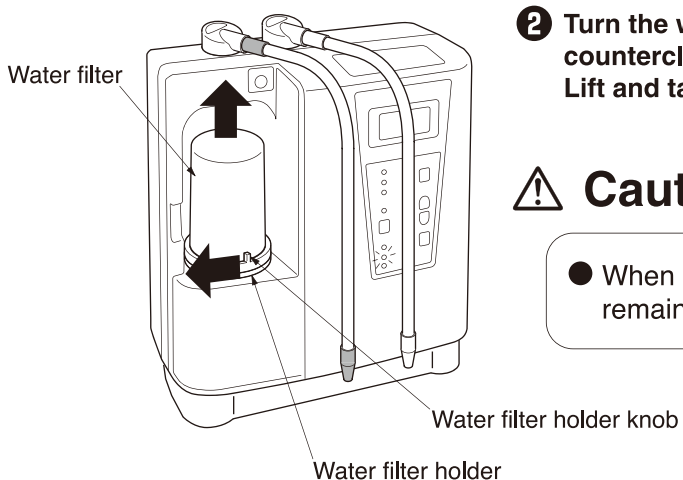
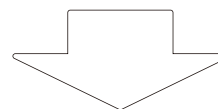

⚠ Caution

- When detaching the filter, be aware that water remaining in the filter may leak.

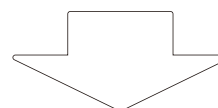

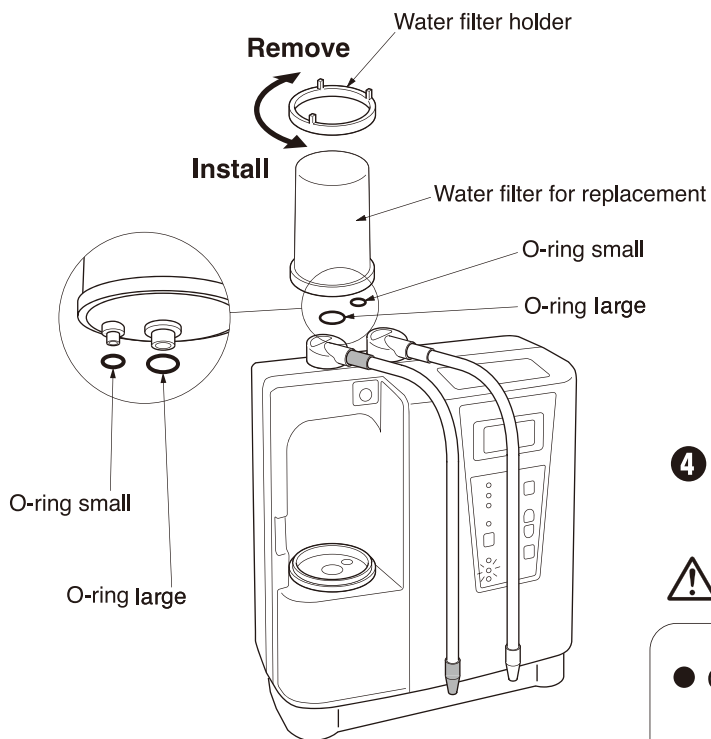

- 3** Insert 2 O-rings (attached) into the new water filter, each take out “each” of the “each at each” of the two locations shown in the figure at left.
(Do not use the old O rings where possible.)

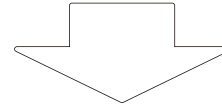

- 4** Perform steps **1** ~ **2** in reverse to install the new filter.

Caution

- Check that the Water filter holder is firmly set.
- After replacing the filter, rotate the holder knob from left to right to align it with the center marking.

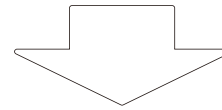
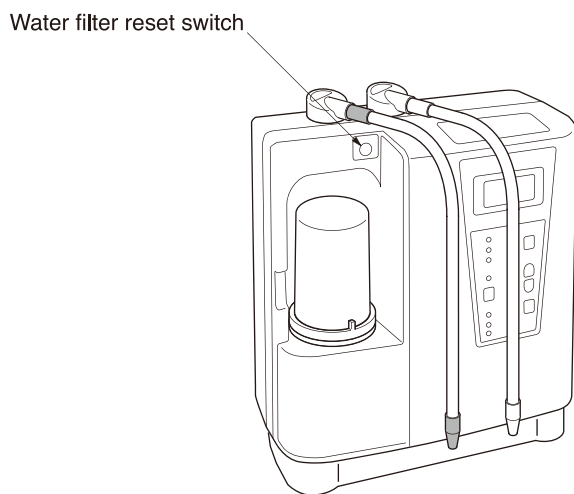

- 5** Press the water filter reset switch.
The filter replacement lamp goes off and activates a beep sound.

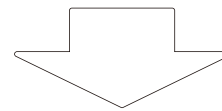
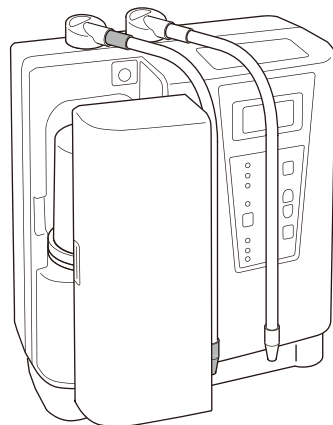

- 6** Replace the water filter cover.

Caution

- Be sure to use our genuine water filter for replacement. (Never use other maker's filters, as they may cause malfunction or other troubles.)

4 Options

■ Options

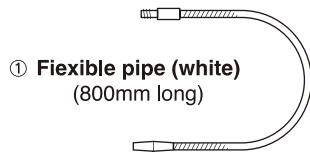

① Flexible pipe (white)
(800mm long)

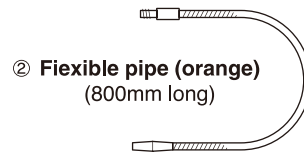

② Flexible pipe (orange)
(800mm long)

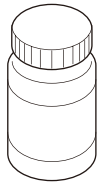

③ Rapid DPD test reagent (25g)
(residual chlorine measuring reagent)

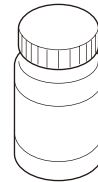

④ Glycerophosphoric acid calcium
TYS-031E

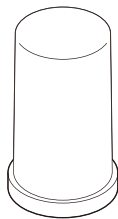

⑤ Water filter for replacement
Activated charcoal type
MW-7000R

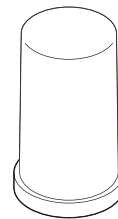

⑥ Water filter for replacement
Activated charcoal type
MW-7000HG



⑦ Glycerophosphoric acid calcium
(12 pcs. 0.1oz/3g each)

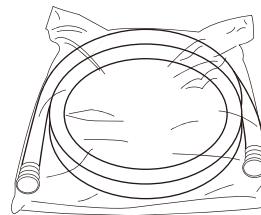

⑧ Water supply hose (2m)

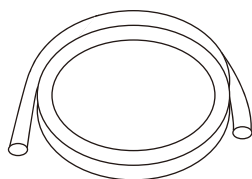

⑨ White hose
(1 - 5m)

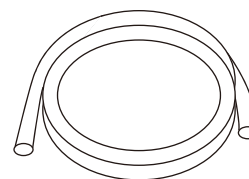

⑩ Gray hose
(1 - 5m)

5

Safety Precautions

- To avoid injury or accident, please adhere to the following rules.

Warning You are requested to observe

- **Please take the following precautions prior to drinking KANGEN Water.**
 - Do not take medication with KANGEN Water.
 - If you are experience any discomfort in your health condition, please consult your physician or pharmacist.
 - If you are under a physician care, or are experiencing physician care, or are experiencing physical abnormality, please consult your physician or pharmacist before using.
- **Use only municipally treated water approved for drinking such as tap water.**
 - The unit's chlorine removal ratio and pH value may vary according to the water quality of different localities.

- **Please supervise children and senior citizens while they use the machine.**
- **This appliance can be used by children age from 8 years and above and persons with reduced physical, sensory or mental capabilities or lack of experience and knowledge if they have been given supervision or instruction concerning use of the appliance in a safe way and understand the hazards involved. Children shall not play with the appliance. Cleaning and user maintenance shall not be made by children without supervision.**

Failure to comply with all of the following warnings may cause electric shock, fire or accidents and can result in severe personal injury and or damage to property.

- **Do not splash water or oil on the body.**
 - **Never run the unit with a damaged power supply cord.**
 - **Do not tamper with or attempt to repair the unit.**
- **Stop use immediately and unplug the power plug when there are aberrations or malfunctions.**

Failure to do this may cause smoke generation, fire ignition or electric shock.
Unplug the power plug, have the product inspected and repaired.

Warning You are requested to observe

- **Do not tamper with or attempt to repair the unit.**

~ It can cause a fire, electric shock or accidents. ~

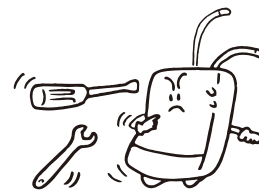

- **Do not splash water or oil to the body.**

~ May cause fire or electric shock. ~



- **Never run the unit with a damaged power supply cord.**

~ It can cause a fire, electric shock or malfunction. ~



⚠ Caution **!** You are requested to observe

- **Do not use the unit when the secondary hose is in an elevated position.**

~ Water cannot flow out of the unit and therefore will cause damage. ~



- **Do not use processed water in aquariums or give to pets.**

~ The change in pH may kill fish or small living things. ~

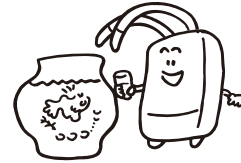

- **Never place anything on the unit.**

~ It may fall over. ~



- **Avoid direct sunlight.**

~ May cause the unit to bend or warp. ~

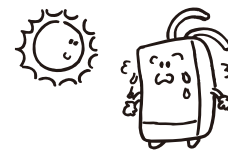

- **Do not place the unit near a hot object or in the presence of corrosive gas.**

~ May damage or cause the unit to bend or warp. ~



- **For cleaning, do not use thinner, benzene, cleansers or chlorine-based detergents.**

~ May damage the unit. ~



- **Do not use salt water or excessively hard water.**

~ The unit may be damaged, or its service life will be shortened. ~

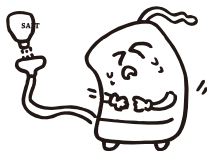

- **Never put pass into water (40°C or higher) into the unit.**

~ It may damage or cause malfunctions. ~

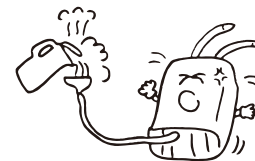

- **When using in winter time or in a cold area, be careful to avoid water freezing in the unit. (When not using the unit for a lengthy period, disassemble the water filter and keep it separately. At this time, do not touch the Reset switch.)**

~ Failure to do so can result in damage or malfunction. ~



- **If this is your first time to drink KANGEN Water. (Reminder: not suitable for taking with medicine.)**

• Begin drinking at a low pH level (8.0) of 1-2 glasses a day for about to weeks to let your body grow accustomed to it. Later increase the pH level to 9.0 to 9.5.

- **If any rash appears**

• Some people who are especially sensitive or allergic may have a reaction to KANGEN Water. In these cases, please discontinue use and consult your doctor.

- **Use municipally treated water approved for drinking, such as city water.**

• The unit's chlorine removal ratio and pH value may vary according to the water quality of different localities.

6

Troubleshooting Guide

■ Before contacting us or your dealer, use the following to self-check for problems.

Trouble ↓	Cause ↓	Remedy ↓
Unit does not come on.	<ul style="list-style-type: none"> ● Unit is not plugged into the outlet. ● Power switch is not turned on. ● Water is not fed to the apparatus. 	<ul style="list-style-type: none"> ■ Insert the power plug into the outlet. ■ Set the switch to the [ON] position. ■ Feed water to the apparatus.
Buzzer sounds.	<ul style="list-style-type: none"> ● Defective condition present. 	<ul style="list-style-type: none"> ■ Follow the instruction on LCD display.
No water comes out during winter.	<ul style="list-style-type: none"> ● The inside the unit is frozen. 	<ul style="list-style-type: none"> ■ Raise the room temperature and wait until it melts.
Output of all types of water is getting low.	<ul style="list-style-type: none"> ● Increase water flow. ● Water filter has clogged. 	<ul style="list-style-type: none"> ■ Open the faucet wider. ■ Replace the water filter with a new one.
KANGEN Water has chlorine odor.	<ul style="list-style-type: none"> ● Water filter is spent. 	<ul style="list-style-type: none"> ■ Replace the water filter with a new one.
Whitish material is floating or has settled in KANGEN Water.	<ul style="list-style-type: none"> ● Calcium processed by electrolysis. 	<ul style="list-style-type: none"> ■ Harmless.
The inside of secondary hose is stained dark.	<ul style="list-style-type: none"> ● Oxidizing material, such as iron has adhered. 	<ul style="list-style-type: none"> ■ Harmless.
Acidic Water does not go lower than pH2.7 when the Strong Acidic Water switch is selected.	<ul style="list-style-type: none"> ● The discharge specific speed is inadequately set. ● No ionizing accelerator. ● Sodium chloride concentration is low. 	<ul style="list-style-type: none"> ■ Check that the level difference between the flexible pipe (orange) and the water discharge hose (gray) is appropriate. ■ Refill sodium chloride. ■ Obtain a concentration of about 20%.
Dropping pH value when processing KANGEN Water and Acidic Water.	<ul style="list-style-type: none"> ● Calcium buildup in the ionizing cell. 	<ul style="list-style-type: none"> ■ Press the [Acidic water] button and run water for about 1 minute to clean the ionizing cell.

Error Messages (List of Messages)

LCD Display	Buzzer Sound	Error Description (Operation)	Countermeasure
INCREASE FLOW	Beep beep beep	Water pressure is low and the specified water level is not reached while producing KANGEN Water, Acidic Water, or Strong Acidic Water (water supply will stop in about 30 seconds).	<ol style="list-style-type: none"> 1. If the Purified Water cartridge is clogged, replace it with a brand-new cartridge. 2. Clean the supply-side strainer. 3. If the flow rate of the original tap water decreases, water service work is required. * Call the toll-free number for consultation.
OVER FLOW	Beep beep beep	Supply pressure is too high in the Strong Acidic Water production cycle, and electrolysis performance is inadequate (the operation will continue until the [Stop] button is pressed).	Contact the dealer from which you purchased the unit.
INCREASE SALT.W  FILL UP SALT.W	Beep-beep-beep, beep-beep-beep N/A	<p>When the ionizing accelerator (sodium chloride) in the sodium chloride tank is used up, the status is indicated by the blinking Low Saltwater Level lamp on the front operation panel.</p> <p>Approx. 1 minute and 30 seconds after the blinking starts, the operation will automatically stop, the lamp will stay lit, and the [Stop] lamp on the top operation panel will start blinking.</p>	Press the [Stop] button or replenish the ionizing accelerator (sodium chloride). Note that, however, by pressing the [Stop] button, only the production of Strong Acidic Water will cease. KANGEN Water, Acidic Water, and Purified Water are produced regularly.
HEAT PROTECT	Beep, beep, beep	The power supply unit is overheated [if the error occurs while KANGEN Water or Acidic Water is used, the unit will stop. (The indicator on the top [Stop] button will blink.) Note that, however, Purified Water and Strong Acidic Water can be produced.]	Press the [Stop] button and reset the unit. Let the power supply unit cool down (it takes about one hour), and resume operation.
HOT RUN PROTECT	Beep, beep, beep	Hot water exceeding 45 degrees C is used while using KANGEN Water, Acidic Water, or Purified Water. (The unit will stop operation, and the lamp on the top [Stop] button will blink.)	Press the [Stop] button, and reset the unit. Let the temperature of the hot water in the unit decrease, and resume operation.
ERROR	N/A	You can use the unit without any problems except that the notification for cartridge replacement timing is disabled.	Please contact the distributor from which you purchased the unit.

7

Leveluk Super 501 Standard Specifications

1	Item name		Leveluk Super 501	
2	Feed water spec and connection		Always-on connection by means of the included hose with nut ; Water supply solenoid valve is included.	
3	Main unit	Dimensions	W 352 mm × H 383 mm × D 250 mm	
		Weight	10.2 kg	
4	Power source		220–240 V AC 50–60 Hz	
5	Power consumption		Approx. 200W	
6	Rated current		1A	
7	Ionizing system		Continuous ionizing system (Dual-line ionizing cell)	
8	Treatment capacity Liter / min.	KANGEN Water	KANGEN Water: 5.0–8.0 L Acidic Water: 1.5–2.5 L	
		Strong Acidic Water	Strong Acidic Water: 1.5 L Strong KANGEN Water: 1.2 L	
9	Electrolysis capacity settings		7 levels	KANGEN Water at 3 levels (Approx. pH8.5/pH9.0/pH9.5) Purified Water (Approx. pH7.0) Acidic Water (Approx. pH6.5) Strong Acidic Water (Approx. pH2.5) Strong KANGEN Water (Approx. pH11.0)
10	Cleaning system of ionizing cell		Automatic cleaning system (with manual cleaning function)	
11	Material of electrode and ionizing cell		Platinum-plated titanium	
12	Filter material		Granulated antibacterial activated charcoal , calcium sulfite	
13	Removable substance		Soluble lead , Residual chlorine (Sterilizer) , Odor and Red rust	
14	Replacement interval		Varies according to region and water quality	
15	Unremovable substances		Metal ions / salt dissolved in original tap water	
16	Applicable water pressure		0.05–0.5 MPa / 6.5–73.0 psi; Water that conforms to the Water Works Law.	
17	Ionizing accelerator (for Strong Acidic Water production)		Sodium chloride pump adding type	Strong Acidic Water
18	Ionizing accelerator re-fill need indication		Advance notice by means of the Low Saltwater Level lamp illumination ; when sodium chloride is used up , the unit makes a forced stop.	
19	Safety provision	Power supply unit	Overcurrent / overvoltage control circuit (Switching power supply) Fuse : 250V 3.15A Thermal protector (Setting temperature 80 degrees C)	
		Hot water	Thermistor	
20	Length of power cord		Approx. 1.5m	

Caution ■ Reactions of pH test liquid with ground water containing free carbonic acid

● In the event that ground or well water is used in place of tap water, because of the ionization of free carbonic acid in the water, the pH of KANGEN Water may return to neutral 1-2 seconds after electrolysis (the pH test liquid turns from blue to green). Despite this, KANGEN Water retains many of its characteristics, tastes good, and is good for your health.

● **Test method** : Put 3 or 4 drops of the pH test liquid in an empty transparent glass. Pour KANGEN Water (pH 9.5) in the glass.

● **Reactions** : The solution turns somewhere between royal purple and blue just after addition of the KANGEN Water, and from blue to green in 1-2 seconds.



After-sales Service

● Warranty

- Please make sure that the date of purchase and your dealer's name are entered on the accompanying Warranty card. Keep it in a safe place.

● If you need repair during warranty period

- The product is guaranteed for three (3) years, excepting only the electrolysis chamber for one (1) year, from the date of purchase.
- For repairs, please contact your local dealer.
(Please read the guarantee conditions carefully, as some repairs may not fall under warranty, depending on the situation.)



Warning

※ You may be charged if your repair falls under any one of the following cases.

1. Trouble resulting from handling in a manner that is not specified in the [Operation Manual].
2. Trouble or damage due to use of water other than municipal drinking water.
3. Trouble or damage due to natural disaster, such as, earthquake, fires or floods.
4. Dropping the product or caused in any traffic accident during transportation.
5. **The guarantee becomes not intended about the malfunction when it was used other than the designated voltage.**
6. Replacement of consumable parts.
7. Replacement of spent electrode.
8. Failure to fill in the [Date of purchase] and [User's Name] and [Dealer's Name] in the warranty form.
9. Purchaser's failure to submit warranty card.

● If you need to repair after warranty expiration

- Contact your local dealer. Repair may be available upon request at purchaser's expense.

● Others

- If you have any questions about the product, please contact your dealer.



Caution



No Disassembly Allowed

In no case should the product be modified, overhauled or repaired by purchaser, as fire or electrical shock could result.

It can cause a fire or electric shock.

Any consequences of such behavior shall not be compensated by the maker.

※ For questions and information, please contact your local dealer.

Los Angeles : TEL. +1-310-542-7700 FAX. +1-310-542-1700	Brazil : TEL. +55-15-3034-4132 FAX. +55-15-3034-4100	Taiwan : TEL. +886-2-2713-2936 FAX. +886-2-2713-2938	Tokyo : TEL. +81-3-5205-6030 FAX. +81-3-5205-6035
New York : TEL. +1-718-784-2110 FAX. +1-718-784-2103	Germany : TEL. +49-211-936570-00 FAX. +49-211-936570-27	Philippines : TEL. +63-2-519-5508 FAX. +63-2-519-1923	Sapporo : TEL. +81-11-223-5678 FAX. +81-11-223-5680
Chicago : TEL. +1-847-430-4013 FAX. +1-847-437-8201	France : TEL. +33 (0) 1 47 07 55 65 FAX. +33 (0) 1 83 71 17 06	Korea(Seoul) : TEL. +82-2-546-8120 FAX. +82-2-546-8127	Nago : TEL. +81-980-51-0616 FAX. +81-980-51-0628
Honolulu : TEL. +1-808-949-5300 FAX. +1-808-949-5336	Italy : TEL. +39-6-3330-670 FAX. +39-6-3321-9505	Korea(Busan) : TEL. +82-51-744-8822 FAX. +82-51-744-8833	Shin-Osaka : TEL. +81-6-6152-5407 FAX. +81-6-6152-5408
Texas : TEL. +1-972-316-7985 FAX. +1-310-531-7111	Australia : TEL. +61-2-9878-1100 FAX. +61-2-9878-1200	Singapore : TEL. +65-6720-7501 FAX. +65-6720-7505	Fukuoka : TEL. +81-92-741-4132 FAX. +81-92-741-4133
Seattle : TEL. +1-425-640-2222 FAX. +1-425-672-8946	Russia : TEL. +7-495-988-02-05 FAX. +7-495-988-02-06	Malaysia : TEL. +60-3-2282-2332 FAX. +60-3-2282-2335	Osaka Factory : TEL. +81-72-893-2290 FAX. +81-72-893-8007
Orlando : TEL. +1-407-601-5963 FAX. +1-407-630-6081	Romania : TEL. +40-374028779	Indonesia : TEL. +62-21-2992-3111 FAX. +62-21-2992-8111	
Burnaby : TEL. +1-604-214-0065 FAX. +1-604-214-0067	Portugal : TEL. +351-22-8305464	Thailand : TEL. +66-2-163-2869 FAX. +66-2-163-2879	
Toronto : TEL. +1-905-507-1200 FAX. +1-416-445-6594	Hong Kong : TEL. +852-2154-0077 FAX. +852-2154-0027	India : TEL. +91-80-4650-9900 FAX. +91-80-4650-9908	
Mexico : TEL. +52-81-8242-5500 FAX. +52-81-8242-5549	Dubai : TEL. +971 4 395 5011 FAX. +971 4 395 5150	Mongolia : TEL. +976-7012-7778 FAX. +976-7012-7708	