

Contents

IMPORTANT SAFEGUARDS /	EN 2
SAVE THESE INSTRUCTIONS	
GROUNDING INSTRUCTIONS	EN 3

Introduction	EN 4
Precautions on the use of Beauty water and	EN 5
Strong Acidic water as well as KANGEN water	
Features	EN 6
Confirming the accessories	EN 7

Name of each part	EN 8
Touch display	EN 9
Installation	EN 10
Installing the diverter	EN 11
Setting up the unit	EN 13
About the power cable	EN 15

Setting menu	EN 16
● Language ● Voice Guidance Volume	
● Brightness ● Sleep	
Check the filter	EN 16

Producing KANGEN water,	EN 18
Clean water, Beauty water.	
● How to measure pH value in KANGEN water	

Strong Acidic water /	EN 20
Strong KANGEN water	
● How to measure pH value in Strong Acidic water	

pH Setting	EN 22
Mineral Additive	EN 22

About the auto cleaning	EN 23
-------------------------------	-------

Replacing the water filter	EN 24
● Guide to replacing the water filter	
● Notification that it is time to replace the water filter	

E-Cleaning	EN 27
------------------	-------

When this display appears	EN 29
Troubleshooting	EN 31

Safety Precautions	EN 32
Options	EN 34
Standard Specifications	EN 35
After-sales Service	EN 36

In this manual

Concerning with “Alkaline electrolytic water” and “Acidic electrolytic water” showing in JIS T2004 “Electrolytic water generator for household use”, we use the technical term of “KANGEN water” and “Beauty water”.

IMPORTANT SAFEGUARDS

• READ ALL INSTRUCTIONS BEFORE USING:

DANGER – To reduce the risk of electrocution:

1. Always unplug this product immediately after using.
2. Do not use while bathing.
3. Do not place or store product where it can fall or be pulled into a tub or sink.
4. Do not place in or drop into water or other liquid.
5. Do not reach for a product that has fallen into water. Unplug immediately.

WARNING – To reduce the risk of burns, electrocution, fire, or injury to persons.

1. A product should never be left unattended when plugged in.
2. Close supervision is necessary when this product is used by, on, or near children or invalids.
3. Use this product only for its intended use as described in this manual. Do not use attachments not recommended by the manufacturer.
4. Never operate this product if it has a damaged cord or plug, if it is not working properly, if it has been dropped or damaged, or dropped into water. Return the product to a service center for examination and repair.
5. Keep the cord away from heated surfaces.
6. Never use while sleeping or drowsy.
7. Never drop or insert any object into any opening or hose.
8. Do not use outdoors or operate where aerosol (spray) products are being used or where oxygen is being administered.
9. Connect this product to a properly grounded outlet only. See Grounding Instructions.

SAVE THESE INSTRUCTIONS

- a) This manual contains instructions for cleaning, user maintenance, and proper operations recommended by the manufacturer such as lubrication, and non-lubrication of this device. All services required by this product must be performed by an authorized service representative, which means that this product contains no user serviceable parts. This product is for household use as stated in this manual and other literature packed with the product.
- b) When a product employing an automatic reset thermallimiter (which shuts off the entire product) is used, please refer to this manual for instructions and warnings.
- c) While the product is in use, please refer to this manual for proper cord maintenance.
- d) The product is intended to be used with water, additives, conditioners, or a product that relies on the conductivity of water for normal operations (electrode type products). The use of baking soda, salt, or other substances to improve the conductivity of the water is stipulated.
Please refer to this manual for specific instructions on the proper liquid or additive and the exact amount to be used in conjunction with the product.

GROUNDING INSTRUCTIONS

This product should be grounded. In the event of an electrical short circuit, grounding reduces the risk of electric shock by providing an escape wire for the electric current. This product is equipped with a cord having a grounding wire with a grounding plug. The plug must be plugged into an outlet that is properly installed and grounded.

DANGER – Improper use of the grounding plug can result in a risk of electric shock.

If repair or replacement of the cord or plug is necessary, do not connect the grounding wire to either flat blade terminal. The wire with insulation having an outer surface that is green with or without yellow stripes is the grounding wire. Check with a qualified electrician or serviceman if the grounding instructions are not completely understood, or if in doubt as to whether the product is properly grounded.

For all other grounded, cord connected products:

This product is equipped with an interchangeable power cord to permit connection with all types of electrical power. (100v-240v) 50-60Hz. Make sure the plug and consent have the same configuration. Do not use adapters with this product. If it will not fit, contact the distributor from whom you purchased this machine from to acquire the correct power plug.

Extension Cords:

If it is necessary to use an extension cord, use only a three wire extension cord that has a three-blade grounding plug, and a three-slot receptacle that will accept the plug on the product. Replace or repair a damaged cord.

Introduction

● Indicators used in this manual

The marks in this manual indicate areas of importance, and are explained below. Be sure to read the Warning and Caution instructions carefully.

Level of danger



Warning

Indicates an imminently hazardous situation which may result in health hazards if the device is handled in a manner other than described in this manual.



Attention

Indicates a potentially hazardous situation which may result in minor or moderate injury if the device is handled in a manner other than described in this manual.

- * All the precautions described here are classified as "⚠ Warning" and "⚠ Attention". Any potential hazardous situation which could result in death or serious physical injury are referred to under the sign "⚠ Warning". However, other potentially hazardous situations referred to under the sign of "⚠ Attention" can also present serious danger, depending on the case and situation. All the precautions, therefore, should be strictly followed.
- * The maker of this product is not responsible for any damage to the product or accidents caused by improper use or by disregarding the precautions mentioned in this manual.
- * After reading this manual, please keep it in a safe place for future reference.

● Description of signal marks



Mark	Title	Significance
	General	Used to indicate general precautions, warnings and dangers.
	General	Used to notify general prohibition precautions, warning and danger.
	General	Used to describe behavior of general users.
	Open flames	Used to warn against any behavior that could result, under certain conditions, in the unit catching fire as a result of proximity to flame.
	Prohibition of use at water splashing place, such as, bath or shower room.	Used to prohibit use of the product through using near baths or in showers, or any place where the unit may come in contact with water, the unit is not waterproof.
	Disassembly	Used to warn against self-repair or taking apart the unit by oneself, which could cause electric shock or other injuries.
	Unplugging	Used to indicate to the user when it is necessary to unplug the product, especially when it is showing signs of being damaged, or when a thunderstorm is expected.

Precautions on the use of Beauty Water and Strong Acidic Water as well as KANGEN Water

Warning - Please observe carefully -

 Please observe	<ul style="list-style-type: none"> ● Please consult with your physician before using Beauty Water or Strong Acidic Water if you have any of the following. <ul style="list-style-type: none"> ■ Sensitive skin ■ Allergies ● If you experience any skin irritation after using Beauty Water, discontinue use and consult with your physician. ● Please take the following precautions prior to drinking KANGEN Water: <ul style="list-style-type: none"> ■ Do not take medication with KANGEN Water. ■ Do not drink KANGEN Water if you have kidney problems such as kidney failure or trouble processing potassium. ■ If you experience any discomfort please discontinue use and consult with your physician. ■ If you are under the care of a physician please consult with them prior to drinking KANGEN Water. ■ Do not use KANGEN Water with baby formula or baby foods.
---	--

Attention

 Prohibited	<ul style="list-style-type: none"> ● Do not drink any of the following types of water; they may negatively affect your health. <ul style="list-style-type: none"> ■ Strong Acidic Water ■ Beauty Water ■ Cleaning cycle water ■ Water containing pH test liquid ■ Strong KANGEN Water during the production of Strong Acidic Water ■ Water being discharged from the secondary water hose ● When drinking KANGEN Water, adjust the pH value to 9.5 or lower. It is not recommended to drink water with a pH over 10.0. Check the pH regularly. ● Do not use KANGEN or Beauty Water in fish bowls or aquariums; changes in pH may kill the fish. ● Do to the fact that copper containers are acid-sensitive and aluminum containers are alkaline-sensitive they should not be used.
 Please observe	<ul style="list-style-type: none"> ● Please drink the KANGEN Water as soon as possible after it is made. ● Use containers made of glass, plastic, ceramic, or other non-corrosive materials when storing Strong Acidic Water. Metal containers will corrode when in contact with Strong Acidic Water and should never be used. ● Store Strong Acidic Water in a tightly sealed container that is impermeable to light. Use stored contents within one week. ● Metal knives or spoons cleaned with Strong Acidic Water or Beauty Water must be dried. Rust can develop if the utensils are left wet. ● Store KANGEN Water in a sealed container and keep refrigerated. Use the contents within 3 days. ● Run water through the machine for 15 minutes when you first use a new filter. ● Let the water flow for more than 10 seconds before your first use of the day. ● If the unit has been unused for 2-3 days, let the water flow for more than 30 seconds. ● Please follow local laws and regulations when disposing of used filters.

Features

• This product is capable of producing 5 types of water, “Strong Acidic Water”, “Strong KANGEN Water”, “KANGEN Water”, “Beauty Water”, and “Clean Water”. All at a touch of the button to suit your specific needs.

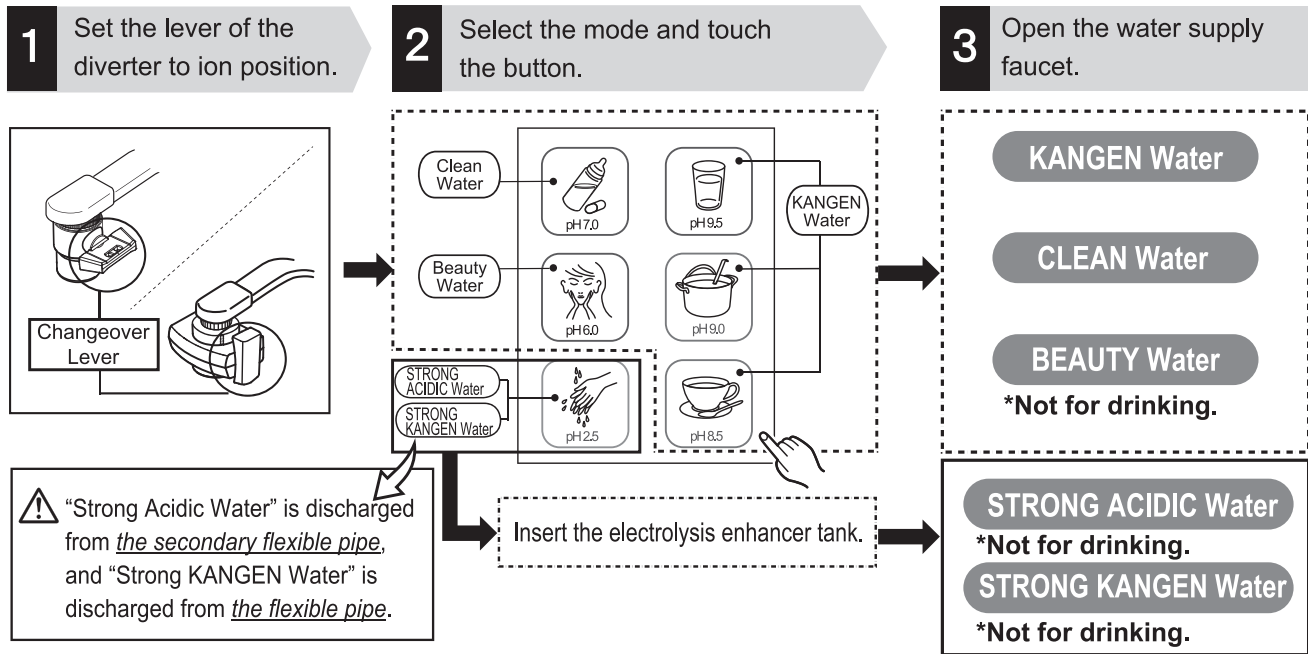

■ 5 type of water, subdivided into 7 according to pH, are available to suit your specific need.

Processed water	button	pH level	Use	⚠ ATTENTION
KANGEN Water		pH 9.5	For everyday drinking Is best for ordinary drinking water, or for making coffee, black tea, oolong tea, and so on.	Not to be used with medicine. When taking medicine, select the CLEAN WATER mode.
		pH 9.0	Once you have become used to drinking KANGEN water Drawing out the flavor of ingredients, food doesn't need as much seasoning, and excess salt can be avoided.	
		pH 8.5	Your Starting Point This pH level is recommended for people to get used to KANGEN Water.	
CLEAN Water		pH 7.0	To be taken with medicine or preparing baby formula The clean water can be used as water to be taken with medicine as well as water you can drink every day.	—
BEAUTY Water		pH 6.0	For your skin care To be used as astringent water, bath water.	Not for drinking.
STRONG ACIDIC Water		pH 2.5	To be used as disinfectant or cleaning This water washes clean your kitchen utensils such as cooking knives, cooking boards, and washes cups and saucers stain-free. It also destroys pathogenic bacteria on fruit.	
STRONG KANGEN Water		pH 11.0	Has the power to dissolve tough stains Use the added power of STRONG KANGEN Water to remove tough kitchen grease stains or cleaning floors. Use to wash fish, meat and vegetables.	

⚠ Warning

Please observe
When producing STRONG ACIDIC Water, please make sure the room is well ventilated and avoid prolonged breathing of the vapors.

Confirming the accessories

If you find anything wrong with the product, please contact the distributor from whom you purchased it.

About installation

- Power cord

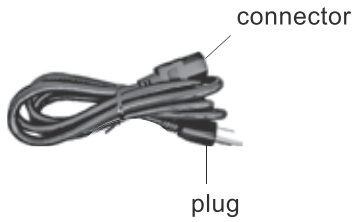

- Operation manual

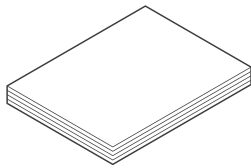

- Stainless Steel Diverter



- Adaptor



Adaptor-T Adaptor-S

- Diverter with Shower

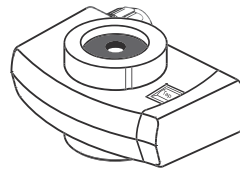

- Adaptor

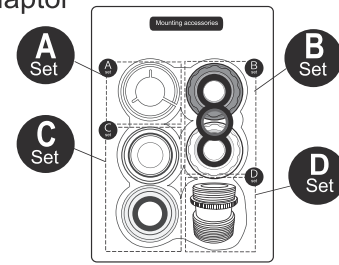

* The power cord provided differ according to the country in which the product is intended to be used.

About the usage

- pH test liquid set

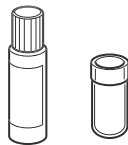

pH test liquid Test tube

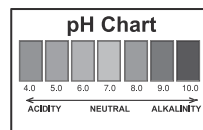

pH color chart

- pH test paper

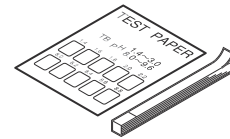

- Cleaning tank



- Electrolysis enhancer



- Cleaning powder

30g×6pcs



- Cleaning cartridge



Name of each part

English

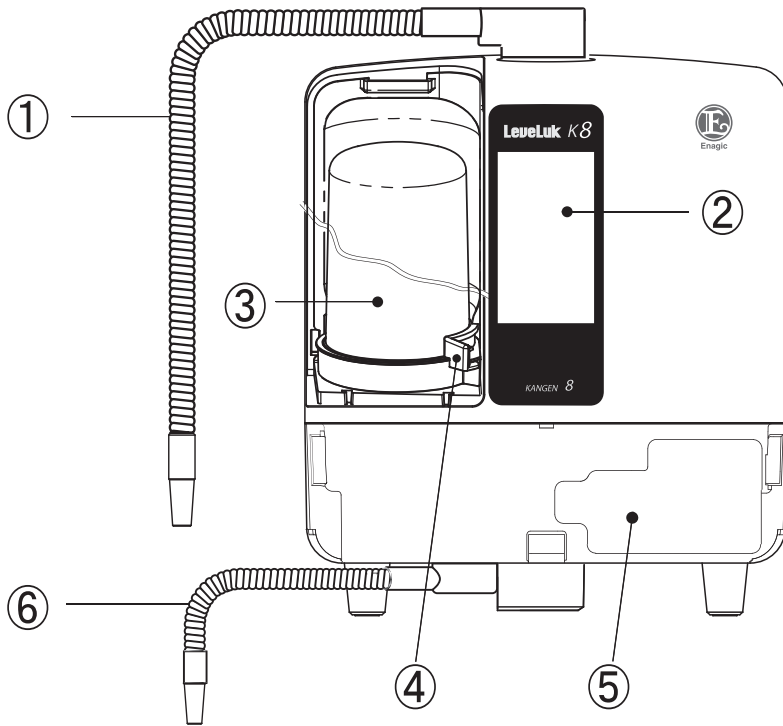

- ① Flexible pipe
- ② Touch display (Display and Operation)
- ③ Water filter (See page EN24)
- ④ Tray holder
- ⑤ Tank
 - The electrolysis enhancer tank (See page EN20)
 - Cleaning tank (See page EN27)
 - Mineral solution tank (optional) (See page EN22)
- ⑥ Secondary flexible pipe
- ⑦ Filter cover
- ⑧ Tank cover
- ⑨ Appliance Inlet
- ⑩ Adjuster <rear only>
- ⑪ Water supply hose

<Top face>

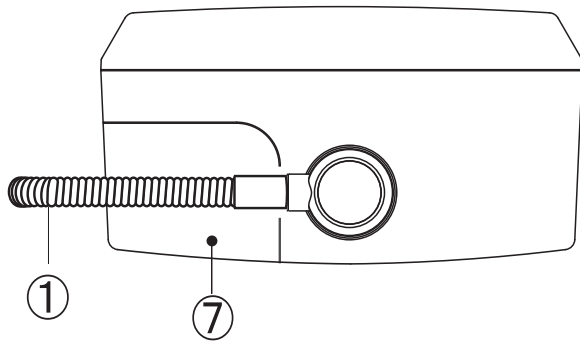

<Bottom face>

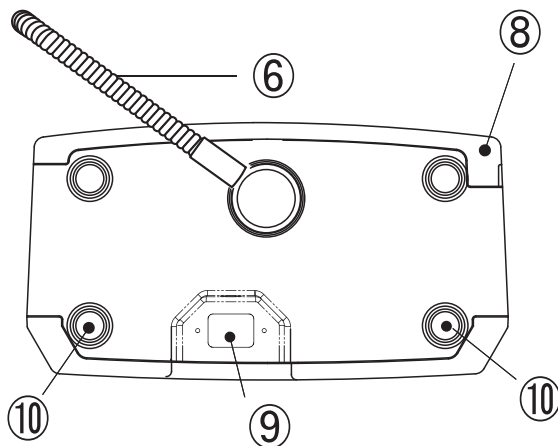

<Rear face>

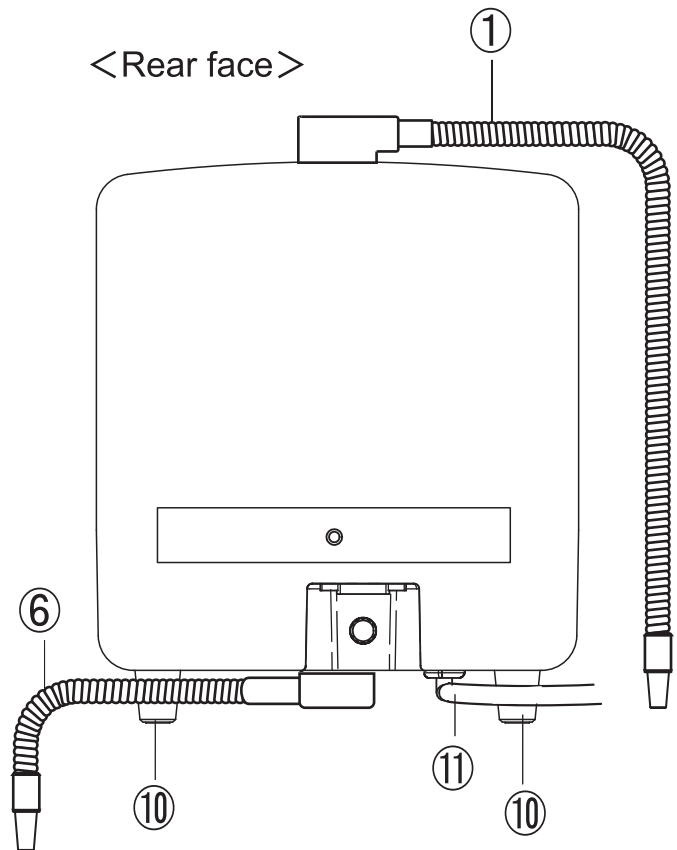

Touch display (Display and Operation)

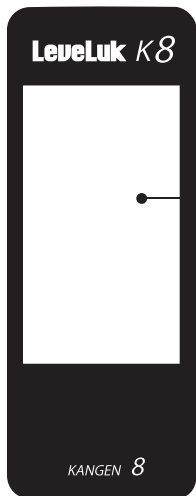

- **Home screen**
- **Setting screen**
- **Attention, Caution screen**
 See page EN29
- **Power Off screen**
 Canceling the OFF condition.(Power ON)
 See page EN17

Basic operation

Operate the touch display by touching it with your finger.

*Precautions for using the touch display.

The touch display is designed to be operated by gently touching it with the finger. Do not press it hard, or press it with a pointed object (your fingernail, or a ballpoint pen, pin, etc.).

The touch display may fail to operate when you touch it in the following ways. Also, note that such behavior may result in a malfunction.

- The touch display may fail to operate when you touch it in the following ways. Also, note that such behavior may result in a malfunction.
- Operating the touch display while wearing gloves
- Operating the touch display with the tip of your fingernail
- Operating the touch display while a protective sheet or a seal is applied to it
- Operating the touch display while it is wet
- Operating the touch display while your finger is damp with perspiration or water

Home screen

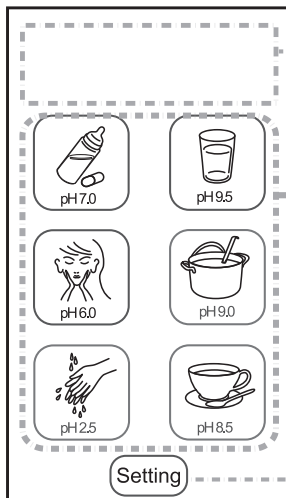

- ① **Display section**
 : Indicates the name of the selected processed water and also the operation when water is being passed through the unit.

- ② **Setting button**
 : Displays the setting screen (refer to the below)

- ③ **Processed water button**
- pH9.5** : KANGEN Water pH 9.5
 - pH9.0** : KANGEN Water pH 9.0
 - pH8.5** : KANGEN Water pH 8.5
 - pH7.0** : Clean Water pH 7.0
 - pH6.0** : Beauty Water pH 6.0
 - pH2.5** : Strong Acidic Water pH 2.5

Setting screen

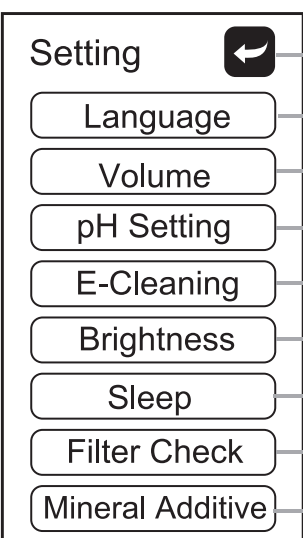

- ① **Language button** : Setting the language (See page EN16)
- ② **Volume button** : Setting the volume (See page EN16)
- ③ **pH Setting button** : Adjusting the pH (See page EN22)
- ④ **E-Cleaning button** : Cleaning inside the unit (See page EN27)
- ⑤ **Brightness button** : Setting the brightness of display (See page EN17)
- ⑥ **Sleep button** : Setting the time of power-off. (See page EN17)
- ⑦ **Filter Check button** : Confirming the filter usage status (See page EN16)
- ⑧ **Mineral Additive button** : Using the mineral tank(optional)
- ⑨ **Back button** : Go back to the previous screen

Installation

Selecting a location





⚠ Attention



Please observe

- Do not place anything on the machine. (Trouble or falling may result.)
- Do not plug the secondary pipe or hose opening. (Can cause water leak or electrolytic error.)
- Check the secondary pipe or hose to see if it is twisted or bent. (Can cause water leak or electrolytic error.)
- Keep the secondary pipe or hose level lower than the level of the machine. (Otherwise, the water in the machine will not drain properly.)
- Before moving or transporting the equipment, either empty the tank or separate the tank from the equipment. May cause damage due to leaking fluid.
- Install this system in compliance with state and local regulations.
- Do not place this product in a location where it disturbs plugging and unplugging of the power cord.

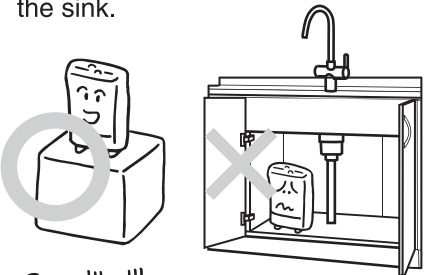
● Install in the following types of location

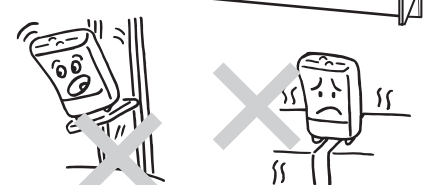
<ul style="list-style-type: none">● In a well ventilated area. 	<ul style="list-style-type: none">● An area away from flammable objects.● In an area with room temperature between 5 to 40°C / 41 to 104°F. 	<ul style="list-style-type: none">● On a flat stable counter top area capable of supporting the weight of the machine. Do not install under the sink. 
<ul style="list-style-type: none">● An area not exposed to direct sunlight, wind or rain. 	<ul style="list-style-type: none">● An area free from splashing water, steam, chemicals and dust. 	

Installing the unit

Install on a kitchen counter.

Note:

Install on a flat place.

Do not connect the product to a faucet used solely for hot water.

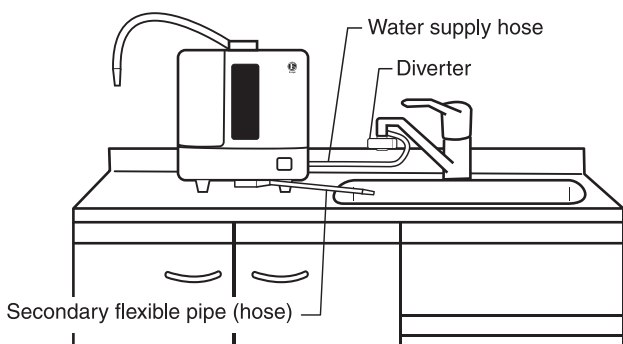

IMPORTANT NOTE :

The original parts used for Enagic products are designed to provide functionality and safety. For this reason, ENAGIC does not approve the use of aftermarket or imitation products. In particular, installing any product other than the SD-U under the sink is strictly prohibited.

-Parts Warranty-

Enagic warranty does not cover damages or failure of its products when used with third party products. ENAGIC is not responsible for failure, accident or damage resulting from the use or modification of parts other than genuine ENAGIC parts.

Installing the diverter (1)

The diverter may not be able to be installed on some types of faucets. Check the type of faucet beforehand. Then fit the diverter on the faucet in the specified manner.

Inner screw type

Remove the Aerator

*Store the removed aerator.

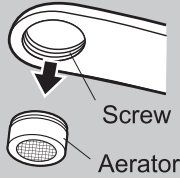

In the case of the Stainless Steel Diverter

<Adaptor used>
T or S

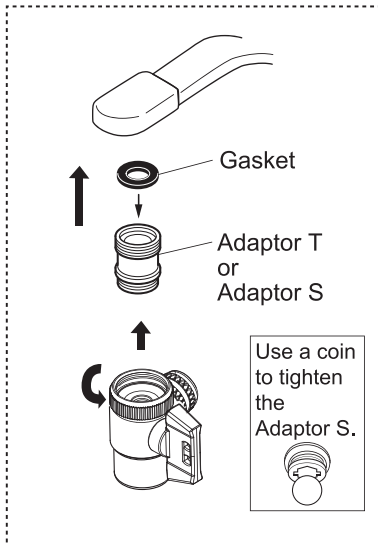

<Installation example>

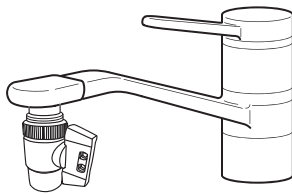

In the case of the Diverter with Shower

Remove the fixing nut.

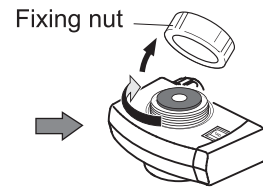

<Adaptor used>
C_{set}

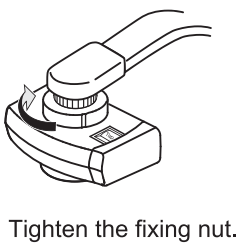
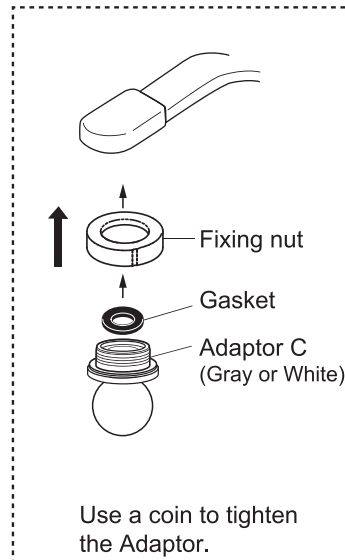

<Adaptor used>
B_{set} + D_{set}

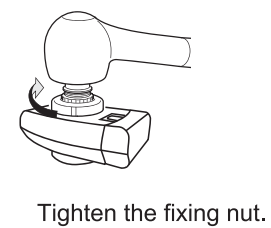
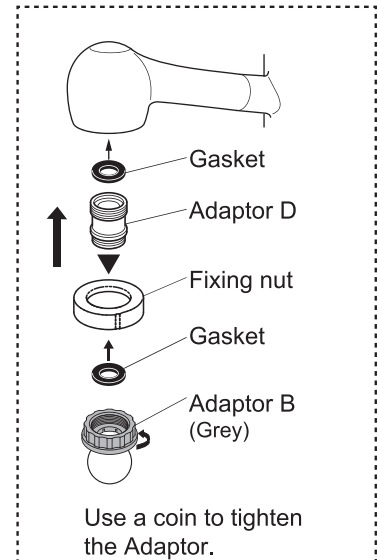

! If the thread diameter or thread pitch does not fit, the threads may get damaged. Make sure the thread diameter and pitch are as specified.

The faucets shown at right cannot accept the diverter.

With a sensor	Screw diameter does not match	Faucet whose nozzle part is short	Square faucets
	<ul style="list-style-type: none"> When the accompanying Adaptor does not fit. <p>φ0.88inch/φ22mm is OK</p>	<p>0.4inch/10mm or smaller 0.96inch/24mm or bigger</p>	

In this case, add a dedicated faucet or install the specific diverter. For details, contact your dealer.

Installing the diverter (2)

The diverter may not be able to be installed on some types of faucets. Check the type of faucet beforehand. Then fit the diverter on the faucet in the specified manner.

Outer screw type

Remove the Aerator

Screw

Aerator

*Store the removed aerator.

Only the Diverter with Shower

< Adaptor used >

B
set

Use a coin to tighten the Adaptor.

Tighten the fixing nut.

Faucet with expanded end

Measure the D dimension, and select one of three fixing rings (16 · 17.5 · 19 mm).

Only the Diverter with Shower

< Adaptor used >

A
set

Tighten the fixing nut.

! If the thread diameter or thread pitch does not fit, the threads may get damaged. Make sure the thread diameter and pitch are as specified.

The faucets shown at right cannot accept the diverter.

With a sensor	Screw diameter does not match	Faucet whose nozzle part is short	Square faucets
	<p>● When the accompanying Adaptor does not fit.</p> <p>φ0.88inch/φ22mm is OK</p>	<p>0.4inch/10mm or smaller</p> <p>0.96inch/24mm or bigger</p>	

In this case, add a dedicated faucet or install the specific diverter. For details, contact your dealer.

Setting up the unit (Diverter : Stainless Steel Diverter)

Overall diagram

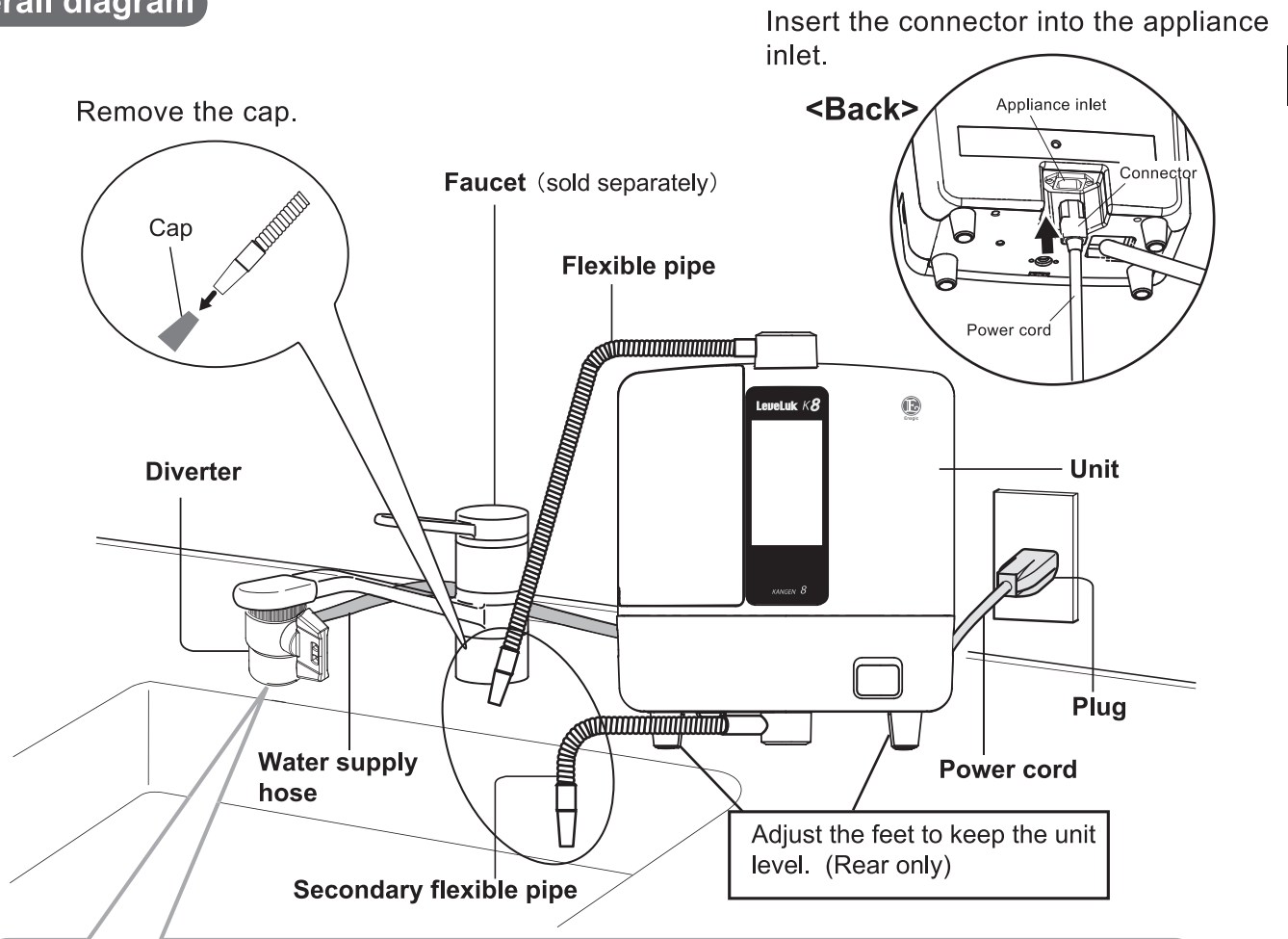

step 1 Remove the fixing nut.

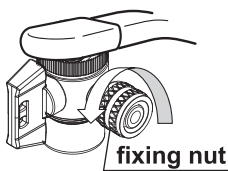

step 2 Fit the fixing nut over the hose, and then fit the hose onto the diverter.

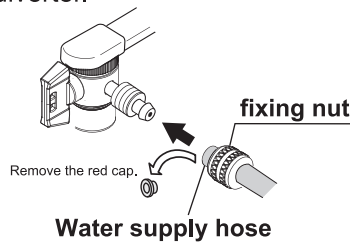

step 3 Insert the hose into the branch plug and secure it by tightening the fixing nut.

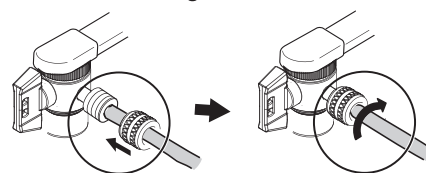

Do not use a tool to tighten the fixing nut because this may cause the nut to break.

Lever

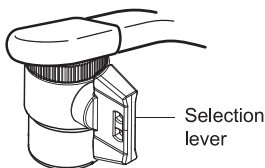

Processed water position	Tap water position
KANGEN Water, BEAUTY Water, STRONG KANGEN Water, or Clean Water flows from the flexible pipe.	Tap water

⚠ Attention

For connection to water mains, the detachable new hose-sets supplied with the appliance are to be used and that old hose-sets are not to be reused.

Setting up the unit (Diverter : Diverter with Shower)

Overall diagram

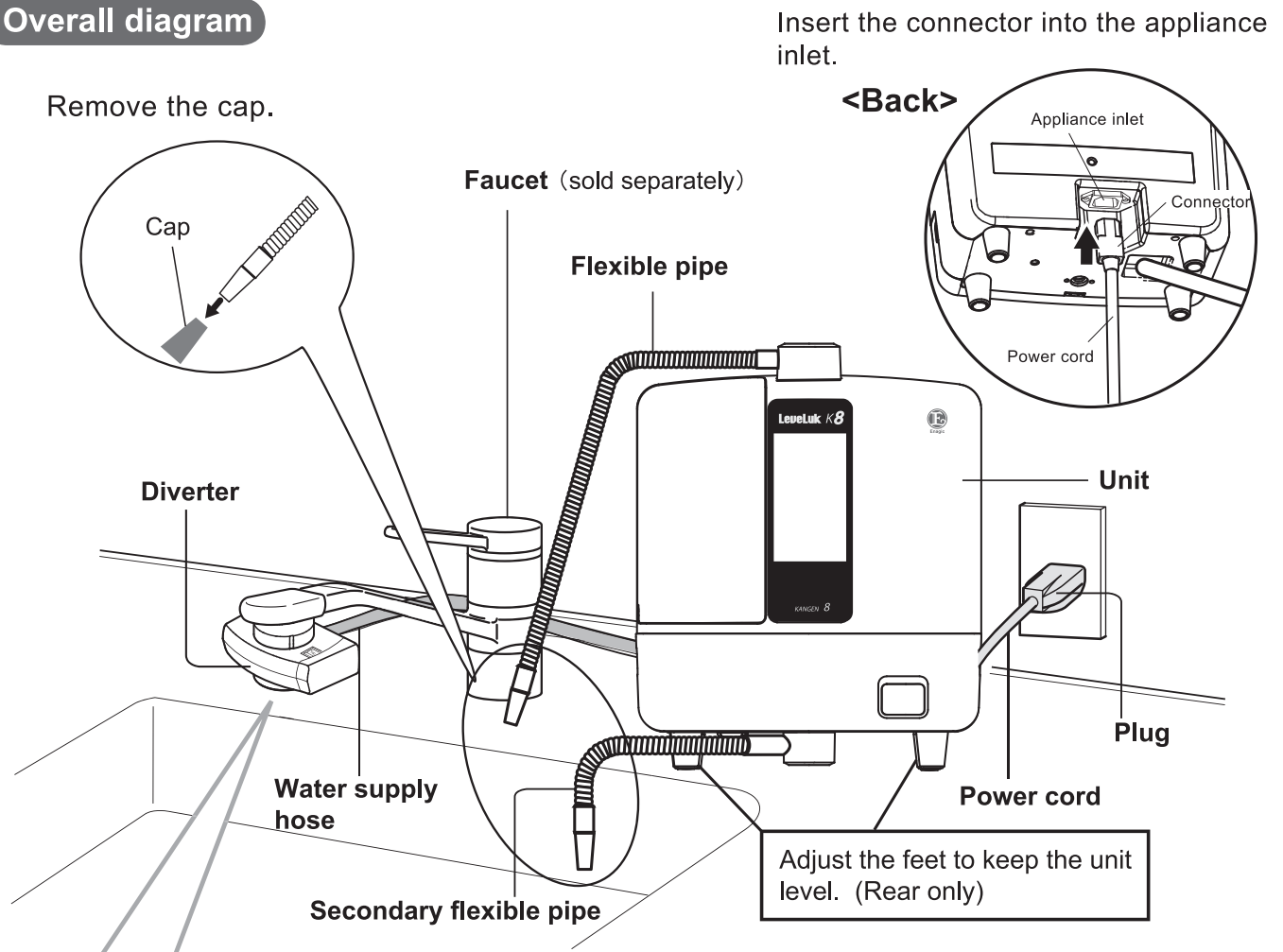

step 1 Remove the fixing nut.

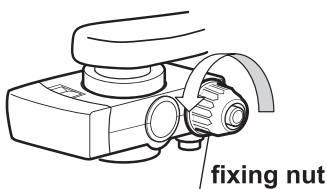

step 2 Fit the fixing nut over the hose, and then fit the hose onto the diverter.

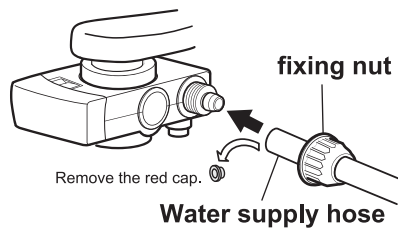

step 3 Insert the hose into the branch plug and secure it by tightening the fixing nut.

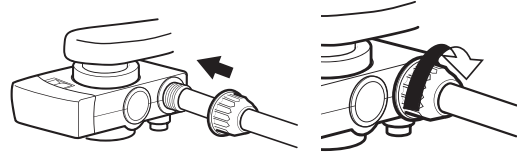

! Do not use a tool to tighten the fixing nut because this may cause the nut to break.

Lever

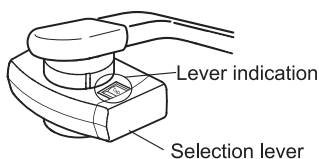

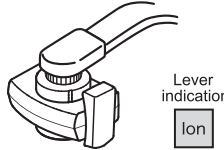
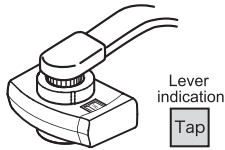
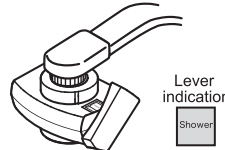
Processed water position	Tap water position	
KANGEN Water, BEAUTY Water, STRONG KANGEN Water, or Clean Water flows from the flexible pipe.	Tap water <Straight>	Tap water <Shower>
		

! Attention

For connection to water mains, the detachable new hose-sets supplied with the appliance are to be used and that old hose-sets are not to be reused.

About the power cable

Please use the outlet of AC 100 - 240 V , 50 - 60 Hz for household use.

*Using improper voltage will void the warranty.

Warning



Prohibited

- Never bend, pull, twist, or bundle the power cord. Do not lay heavy objects on top of the cord or clamp the cord: This may damage the cord, and cause electric shock that may lead to hazardous fire.
- Do not use a damage power cord or loosely fitted one. It may cause electric shock, short circuit or fire.
- Stapling the power cord is strictly prohibited. This will cause irreparable damages to the cord and possibly fire.
- Do not plug too many plugs into one outlet.
- Use only the proper power supply/voltage. Use improper power source/voltage can cause fire or electric shock.

Attention



Please observe

- Insert the power plug and the connector firmly. If the plug and connector is not inserted properly, electric shock or a fire caused by heat generation may result.
- Be sure to check that all buttons work properly.
- Connect or disconnect the power plug by holding the plug instead of the cord. Pulling the cord can cause breakage, fire, and/or electric shock.
- Please bundle the cord during storage to avoid damage.
- If the supply cord is damaged, it must be replaced by the manufacturer, its service agent or similarly qualified persons in order to avoid hazard.



- A wet plug can cause electric shock. If the power plug is severely wet
 - (1) Disconnect the plug from the outlet
 - (2) Wipe the water off the plugs
 - (3) Consult yours local dealer for repairs
- Never handle power plugs with wet hands. If power plug is wet, first disconnect it completely from the outlet and wipe it dry. Failure to follow these procedures may result in electric shock.
- When cleaning the outlet, first disconnect the power plug. Dust on outlets can cause fire.
- Always unplug this product after use.

Connecting the Power Cord



Please check that you are using the proper power cord for your area, prior to plugging in the machine. Other power cords are sold separately. Please contact your distributor for details.

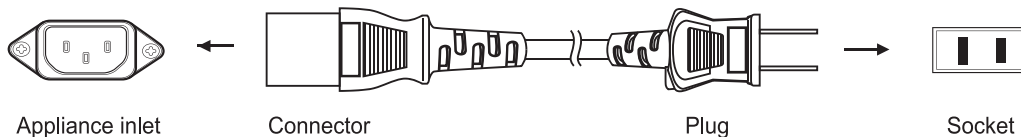

Region	Japan	USA/CAN	Europe	Australia/China	UK	Switzerland	Italy	Brazil
Plug Type								
Socket Type								
Voltage (almost always)	100 V	120 V	220 - 240 V	220 - 240 V	220 - 240 V	220 - 240 V	220 - 240 V	127/220 V
Code.	JPN	USA/CAN	EU	AUS	GBR	CHE	ITA	BRA

Setting menu

Setting the language You can set the language.

step 1 **Go to Settings >Language**
: Select "Setting" in the home screen and touch "Language".

step 2 **Touch the item on the screen corresponding to the desired language.**
: A voice guidance message will be played in the set language.

Ex.) The language has been set to English

step 3 **Touch the back button**
: Back to the setting screen.

<Language screen>



Default: English

Setting the volume You can set the volume level of the voice guidance

step 1 **Go to Settings >Volume**
: Select "Setting" in the home screen and touch "Volume".

step 2 **Touch the button (High Low Off) corresponding to the desired volume level.**
: The selected volume level will be set.

Button	Meaning
High	Sets the volume level to high.
Low	Sets the volume level to low.
Off	Mutes the voice guidance.

* You cannot change the operation tone.

<Volume screen>

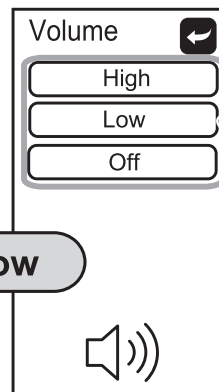

Default: Low

step 3 **Touch the back button**
: Back to the setting screen.

Check the filter Indicates the usage of the current filter. Use as a rough guide to the time remaining until the filter is to be replaced.

step 1 **Go to Settings >Filter Check**
: Select "Setting" in the home screen and touch "Filter Check".

- A** Indicates the total amount of water passed through the filter.
(Rough guide to the time remaining until the filter is to be replaced: Approx. 6000 L)
: 「」 One graduation mark is approx. 1000 L.
- B** Indicates the total time that the filter has been installed.
(Rough guide to the time remaining until filter replacement: Approx. 1 year)
: 「」 Approx. two months per graduation

As the amount of water used or the time during which the unit is used increases, the () bars change progressively to (). When (Replace) becomes red, it is time to replace the filter.

* A rough guide to the time remaining until the water filter is to be replaced is the value obtained from a test using standard water quality and water pressure (JIS S 3201 Testing Methods for Household Water Purifiers). When using general tap water, the replacement time may differ according to the water quality and the water pressure.

<Filter check screen>

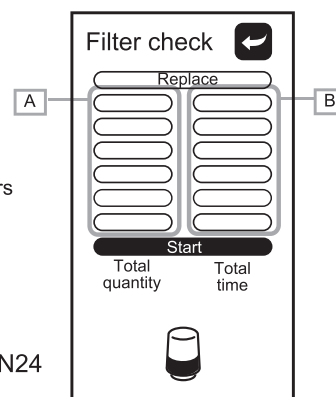

Replacing the water filter See page EN24

step 2 **Touch the back button**
: Back to the setting screen.

Setting the brightness

You can set the brightness of the screen.

step

1 Go to Settings >Brightness screen

: Select "Setting" in the home screen and touch "Brightness".

step

2 Touch the button (**Bright** **Natural** **Dark**) corresponding to the desired brightness.

: The selected screen brightness will be set.

step

3 Touch the back button 

: Back to the setting screen.

<Brightness screen>

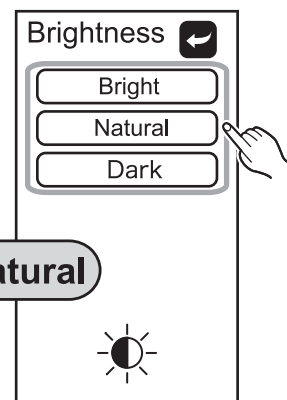

Setting the sleep

If you do not perform an operation for a certain fixed time, the screen and the power will turn OFF. You can set this fixed time as desired.

Screen example



Lapse of time during which no operation was performed.

Default: 1 min



<Power OFF screen>



Touch the screen or run water through the unit.



Canceling the OFF condition (Power ON)

- Touch the screen
-The screen appears.
- Run through the unit
-The processed water that you selected before the unit switched OFF is discharged. (KANGEN WATER)

step

1 Go to the Settings >Sleep

: Select "Setting" in the home screen and touch "Sleep".

step

2 Touch the button (**1 min.** **2 min.** **3 min.** **4 min.** **5 min.**) corresponding to the desired time.

: The time the unit turns off automatically will be set

step

3 Touch the back button 

: Back to the setting screen.

<Sleep screen>

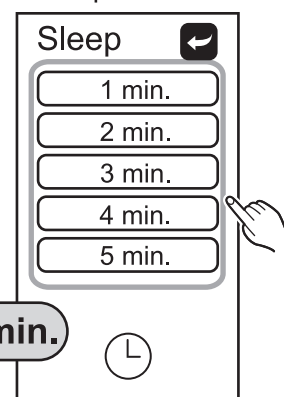

Producing KANGEN Water, Clean Water, Beauty Water

Always use water with a temperature under 35°C / 95°F. (Failure to observe this precaution may cause the water filter and the main body of the unit damage.)

step

1 Move the faucet lever to the processed water position.

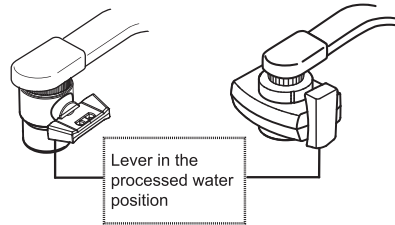

Warning

You cannot drink Beauty water.
Check page EN6 concerning the use of processed water.

step

2 Touch the desired button on the Home screen.



*Power ON : Touch the screen or pass water through the unit.

: The name of the processed water that you selected using the display selection appears, and a voice is output. (See the figure below.)

step

3 Open the faucet to run water through the unit.

- : Processed water will be discharged from the flexible pipe.
- : The indication of water running appears on the display, and a voice is output. (See the figure below.)

*The pH value varies according to local water characteristics and water pressure.

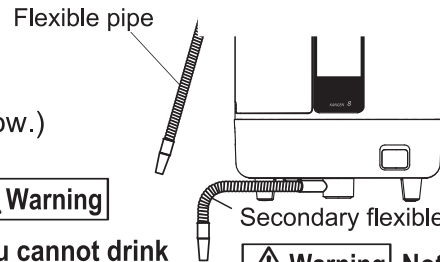

Warning

You cannot drink Beauty water.

Warning

Not for drinking

step

4 Turn off the faucet to stop production of water.

: If you wish to produce water continuously, follow step **3** of the operation procedure.

Screen display and voice guidance

Screen	Select button	pH level	After touching a selection button		When water is being run through the unit	
			Display section	Voice	Display section	Voice
		pH 9.5	KANGEN WATER	KANGEN WATER 9.5	KANGEN)))))))))	KANGEN WATER 9.5
		pH 9.0	KANGEN WATER	KANGEN WATER 9.0	KANGEN)))))))))	KANGEN WATER 9.0
		pH 8.5	KANGEN WATER	KANGEN WATER 8.5	KANGEN)))))))))	KANGEN WATER 8.5
		pH 7.0	CLEAN WATER	Clean water	CLEAN)))))))))	Clean water
		pH 6.0	BEAUTY WATER	Beauty water	BEAUTY)))))))))	Beauty water

How to measure pH value of KANGEN Water

• Measure the pH value of the KANGEN Water by using the pH test liquid at least once a month.

Optimum pH

Potable range ... pH8.5~9.5

About the pH test liquid

This test liquid is used to periodically measure the approximate value of the pH.
*The pH test liquid can not measure the pH below 4.0.

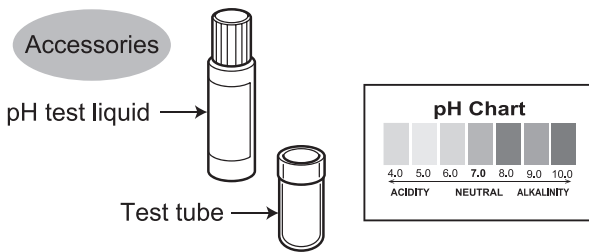

⚠ Attention

- Do not drink the water in the test tube after testing.
- Keep the testing liquid in a cold and dark place.
- Store the pH testing liquid set out of children's reach.

step **1** Put KANGEN Water in the included test tube about 0.8 in.(2cm) deep.

- The pH is unsteady in water initially processed. Therefore, flow the water for approximately 10 seconds before sampling.

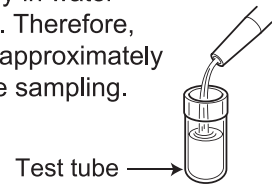

step **2** Add about 1~2 drops of test liquid in the tube and shake the content well.

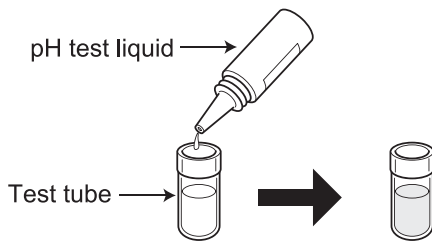

step **3** Compare the color of the water in the test tube with that of the color chart paper and check the pH concentration.

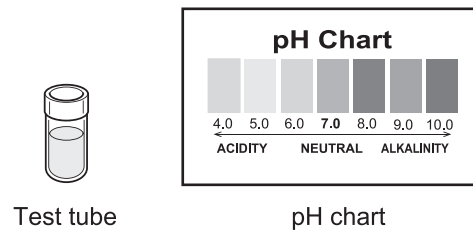

⚠ Attention

- When the water filter is new (approx. 1 week), the pH is sometimes slightly high.
- The pH value varies according to local water characteristics and water pressure.

Concerning the result of measuring the pH value

pH measurement result

A pH value that is within the normal range is not obtained.

Low

Mineral Additive (optional)

page EN22

High

pH Setting

page EN22

Still high

Use mixed with purified water.

The value is lower than the normal range.	[Cause] <ul style="list-style-type: none"> • The hardness of the tap water is low, and the water does not readily become alkaline. • Well water or other water that contains a large amount of carbon dioxide gas. • The electrolyzing performance of the unit has decreased. → E-cleaning (page EN27)
The value is higher than the normal range.	[Cause] <ul style="list-style-type: none"> • The tap water is very hard, and readily becomes alkaline. • The cartridge is new. → Continue to use as is. (Measure the pH again after one week.)

Producing Strong Acidic Water / Strong KANGEN Water

Always use water with a temperature under 35 °C / 95 °F. (Failure to observe this precaution may cause the water filter and the main body of the unit damage.)

step

1 Move the faucet lever to the processed water position.

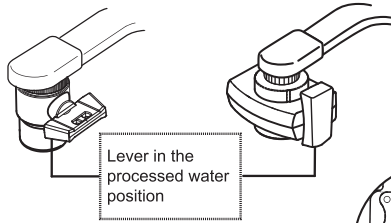

Warning

You cannot drink Strong Acidic Water or Strong KANGEN Water. When you wish to use processed water, check page EN6.

step

2 Install the electrolysis enhancer tank.

- ① Remove the tank cover and remove the electrolysis enhancer tank. Remove the cap and place electrolysis enhancer into the tank. Replace the cap and tighten it.
- ② Install ① in the tank mounting position.
- ③ Replace the tank cover.

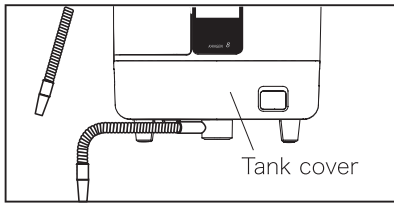
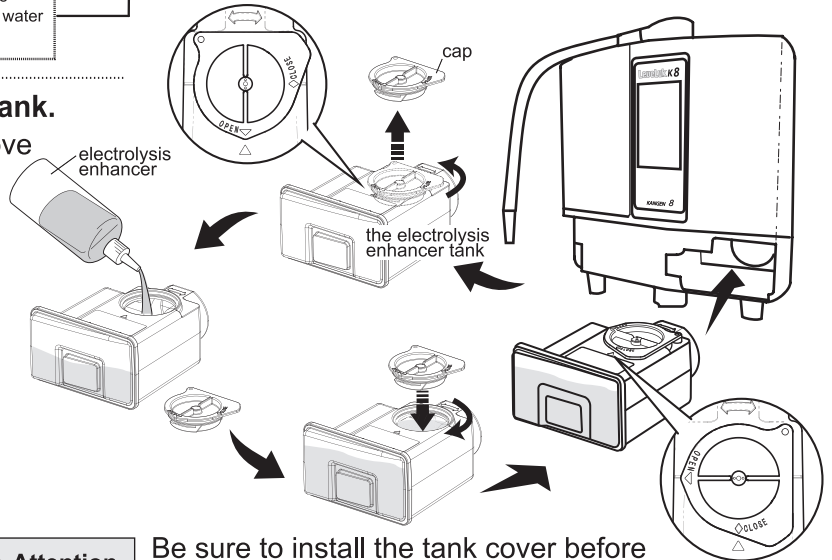

Attention

Be sure to install the tank cover before using the tank.

If you use the tank without installing the tank cover, you will be unable to recognize the tank, which may result in an error.

step

3 Touch the select button  on the Home screen.

*Power-on : Touch the screen or run the running water.

Display section	 Voice
STRONG ACIDIC WATER	Strong acidic Water

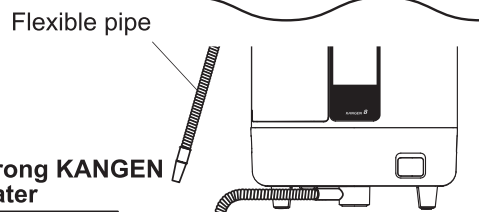
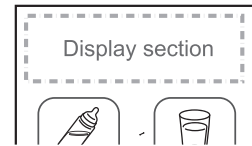

Strong KANGEN Water

Warning
Not for drink

Strong Acidic Water
Warning Not for drink

step

4 Open the faucet to run water through the unit.

: Strong KANGEN Water is discharged from the flexible pipe.
Strong Acidic Water is discharged from the secondary flexible pipe.

Display section	 Voice
STRONG)))))))))	Strong acidic Water

* The pH value varies according to local water characteristics and water pressure.

Warning

- When you use enhancer fluid for the first time or after refilling the enhancer tank, it will take about 30 seconds for the enhancer fluid to enter the electrolysis chamber.
- If the indication, "Out of enhancer" does not go away in about 30 seconds lower the flow rate.

step

5 Turn off the faucet to stop production of water.

: If you wish to produce water continuously , follow step **3** of the operation procedure.
: Select another mode and continue to run water until the cleaning mode stops.

 See page EN23

How to measure pH value of Strong Acidic Water

- The pH test liquid can not measure the pH below 4.0. For measuring the pH value of Strong Acidic Water, use the pH test paper.

step
1 Pour strong acidic water from the secondary flexible pipe into a cup.

*The pH is unsteady in water initially processed. Therefore, flow the water for approximately 10 seconds before sampling.

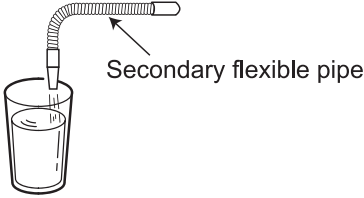

Secondary flexible pipe

step
2 Carefully dip the pH test paper in the water sample (less than half a second). Shake the pH test paper gently to remove excess water.

*Dipping the test paper too long (longer than 1 second) causes the pigment to be dissolved into the sample water resulting in inaccurate test results.

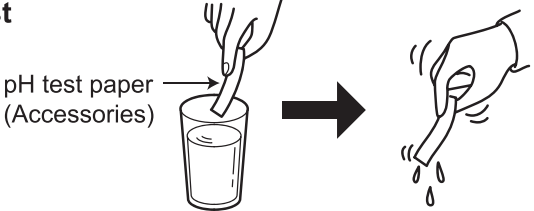

pH test paper (Accessories)

step
3 Check the color of the wet portion of the paper to the color chart in a brightly well lit place. (less than 5 seconds.)

*The consequence of leaving the pH test paper exposed to air for a long period of time may lead to inaccurate results.

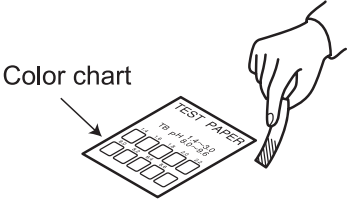

Color chart

⚠ Attention

- The pH test paper can only be used to check the pH value of Strong Acidic Water.
- Do not lick the pH paper. If you do, rinse out your mouth and gargle immediately.
- The pH test paper must be kept in cool, dry, and dark places.
- Store the testing liquid and paper out of reach of children.

Result of pH measurement

Result of pH measurement

The pH value does not fall below 2.7.

- There is too fast of water flow.
 - ➔ Turn the faucet so as to reduce the flow of water.
- The electrolysis enhancer tank is empty.
 - ➔ Replace the electrolysis enhancer tank with a full one.

⚠ Attention • Reactions of pH test liquid with ground water containing free carbonic acid

In the event that ground or well water is used in place of tap water, because of the ionization of free carbonic acid in the water, the pH of KANGEN Water may return to neutral 1~2 seconds after electrolysis (the pH test liquid turns from blue to green). Despite this, KANGEN Water retains many of its characteristics, tastes good, and benefits.

- Test method** : Put 3 or 4 drops of the pH test liquid in an empty transparent glass. Pour KANGEN Water (pH 9.5) in the glass.
- Reactions** : The solution turns somewhere between royal purple and blue just after adding the KANGEN Water and from blue to green in 1~2 seconds.

pH setting

If the pH value becomes lower (higher) than the value in “Guide to pH,” you can adjust the strength of the current and finely adjust the pH value.



step

1 Go to the Setting >pH setting

: Select “Setting” in the home screen and touch “pH setting”.

step

2 Touch [+] or [-] to adjust the strength of the current.

Button	Description
	Increases the current. The pH value rises.
	Decreases the current. The pH value falls.

Default: 4

< pH setting screen >

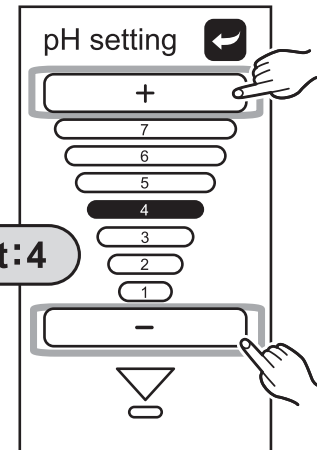

step

3 Touch the back button 

: Back to the setting screen.

Mineral Additive (Optional)

Potable range : pH8.5 ~ 9.5

If the pH value remains lower than the normal range, add calcium lactate (must be purchased separately). If the pH value is within the normal range, there is no need to add calcium lactate.

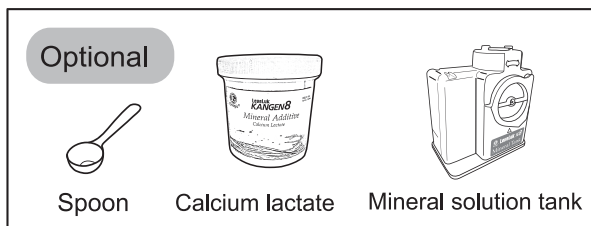

step

1 Put 20g of calcium lactate (5 spoonfuls using the attached spoon) and 400ml of lukewarm water into a container, dissolve it completely so that it does not become lumpy, then put it in the mineral tank.

step

2 Install the mineral solution tank of step **1** in bottom right of the main body of the unit.

step

3 Go to the Setting >Mineral Additive

: Select “Setting” in the home screen and touch “Mineral Additive”.

step

4 Touch **Yes**, then touch the button  until the Home screen appears.

step

5 Select the desired KANGEN water.

< Mineral Additive screen >

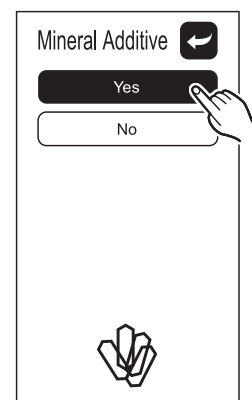

Attention

- To ensure that the tank is correctly recognized, be sure to install the tank cover before using the machine.
- Calcium lactate (optional) increases the calcium concentration in the KANGEN Water.
- After use, wash the inside of the mineral solution tank so that no calcium lactate liquid remains, then carefully wipe away moisture, and allow the tank to dry.

About the auto cleaning

Calcium deposited on the electrodes in the electrolysis tank may result in degraded water. This unit automatically cleans the tank.

KANGEN Refresh

When KANGEN water, Beauty water, or Strong Acidic Water has been used for more than 10 minutes.

When the faucet is closed

KANGEN refresh takes place (approx. 10 seconds).



Attention

Do not use the water that comes out from the pipe or hose.

<Screen display>

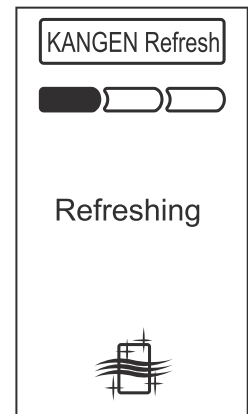

Cleaning

- When another processed water mode is to be selected after making Strong Acidic water.
- When the unit has not been used for more than 24 hours.

* When cleaning is to be carried out at the commencement of the next processed water operation, a "Cleaning Notification" indication will appear.



Attention

• While the unit is producing the kinds of water listed above, the unit will not switch over to the automatic cleaning mode. The unit will automatically clean the next time the unit is productive.

<Screen display>

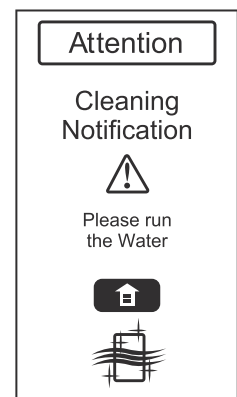

When water is run through the unit

Carrying out cleaning (approx. 30 seconds)

While continuing to run water through the unit, wait until cleaning is completed.



Attention

Do not use the water that comes out from the pipe or hose.



Voice

"Starting the cleaning cycle."



"The cleaning cycle is finished."



Attention

You can not select the "E-cleaning" until the cleaning cycle is completed. If you want to do the "E-cleaning", be sure to run water through the unit and completed the cleaning cycle.

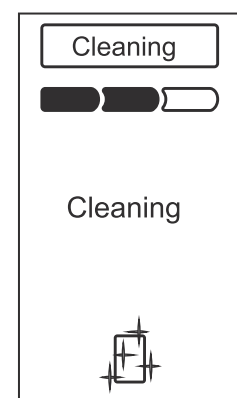

Replacing the water filter

The water filter is a standard accessory that comes with a new unit.
 (Replacement activated charcoal water filters are available. Contact your local dealer.)

Replacement water filter of this product : F8 WATER FILTER

Guide to replacing the water filter

Total amount of water run through the filter: 6,000 liters (a)

Period of use: Approximately 1 year

The flow volume of each kind of processed water is extremely small (clogged).

(a) Value indicated in JIS S 3201 Testing Methods for Household Water Purifiers.

Attention Rough guide to the period of use

•When using general tap water, the replacement time may differ according to the water quality and the water pressure.

Filter check See page EN16 ■ You can check the condition of use of the cleaning filter by observing the screen. Use the screen indication to help you prepare a new filter.

Notification that it is time to replace the water filter

When either the total amount of water run through the unit or the time during which the unit has been used reaches the approximate value at which the filter must be replaced, you will be notified by a screen display and voice guidance.

Voice

「It's time to replace the filter」

Attention

- The message does not appear while water is running.
- No notification instructing you to replace the filter due to clogging is output.

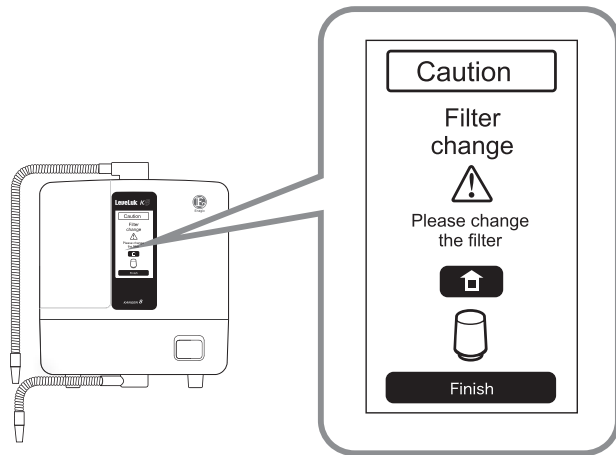

*Replace the filter if the water smells or has a strange taste, even if notification instructing you to replace the filter is not output.

button	subject
	Back to the Home screen. (Only 5 seconds)

When the "Filter change" indication appears

Replace the water filter with a new one. → To the next page

When you cannot replace the filter immediately, → Touch the Finish button **Finish**

*If filter replacement has not been completed, the "Filter change" indication will re-appear after about 2 weeks.
 If you continue to use a filter that has exceeded its target replacement time, the unit is liable to malfunction, so replace the filter as soon as replacement becomes necessary.

How to replace the water filter

⚠ Attention

- Do not pull out the power plug or connectors.
- Do not push over the unit or aim the flexible pipe upward.
- Replace the water filter after stopping the water from flexible pipe and secondary flexible pipe.

Please wait for the machine to finish draining before changing the water filter.

step

1 Remove the filter cover.

While pushing the arrow mark () on the side of the unit, slide the cover upward and remove it.

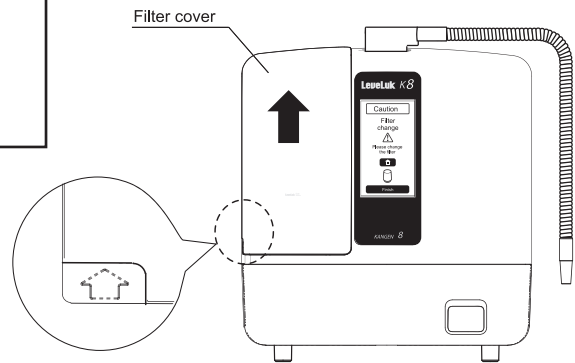

step

2 Remove the water filter.

Slide the holder knob to the left and release the holder, then pull up the filter and remove it.

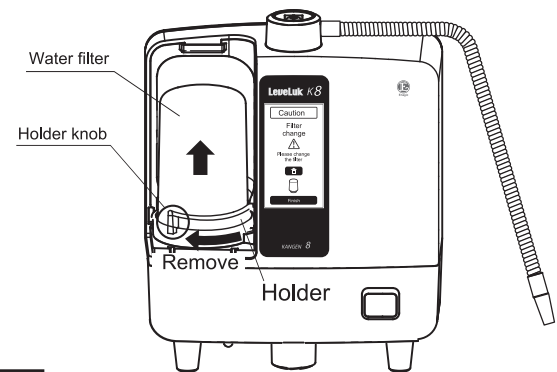

⚠ Attention

Be careful of water leaking out of the filter when removing the filter.

step

3 Install a replacement filter.

Check to ensure that the old O rings do not remain on the filter tray, and then push in the replacement filter while being careful of the installation position. Install the holder, then slide the holder knob to the right and lock it in place.

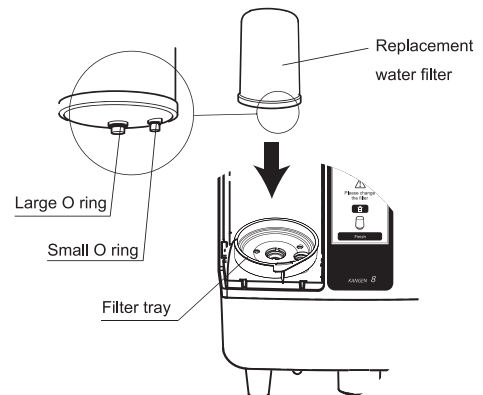

⚠ Attention

- Check to see if the two O rings have been fitted onto the water filter.
- Check to see if the holder is securely in place.

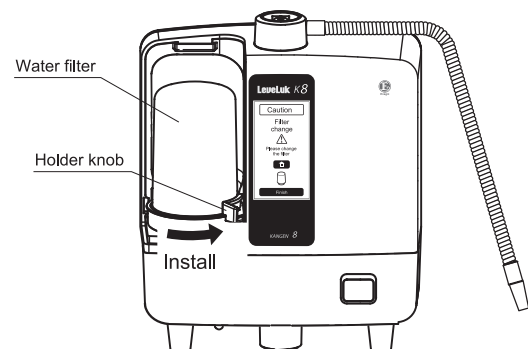

Continued on the next page.

How to replace the water filter

step

4 Replace the water filter cover.

Fit the three tabs at the bottom, then slide the cover downward and engage the tabs with the tabs at the top.

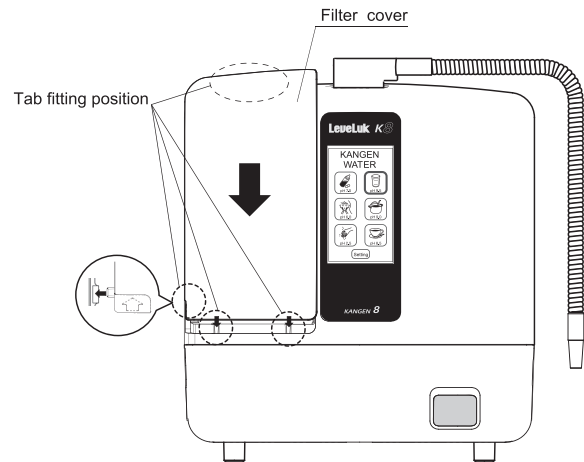

When using genuine filter

The filter history is reset automatically and the screen display reverts to the main screen.

"The filter has been reset"

When using non-genuine filter

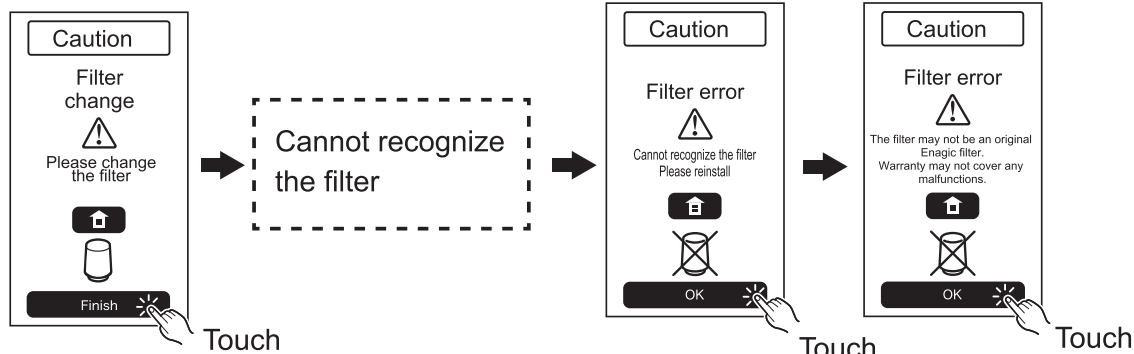

button	subject
	Back to the Home screen. (Only 5 seconds)

"The filter has been set"

Attention

Approximately two weeks after installation of a non-genuine filter or exceeding the recommended water flow amount or usage time, "Filter change" is displayed.

Non-genuine filters are not manufactured to specifications suited to this product, so their use may result in damage and void your warranty.

Please purchase genuine filters at the Enagic Online Shop or other locations that sell our products.

Attention

- Run water through the unit for 3 to 4 minutes when you first use a new filter.
- Please ensure that the spent water filter (combustibles) observe the regulations of the region. (The material of water filter case is ABS resin. Please refer to page 35 standard specifications for inside filtering material.)

E-Cleaning

Remove calcium adhering to the inside of the unit.

⚠ Attention

Items to be obtained

water:370ml	Cleaning powder	Cleaning tank	cleaning cartridge	Cap (red: 1 pc)

- Use two packets of our cleaning powder for one cleaning operation. The use of another manufacturer's powder may cause damage to the unit.
- If the cleaning solution gets into your eyes, wash it away immediately.
- Please use the cleaning powder once every week or two weeks.

The cleaning powder contains citric acid, which is commonly used as food additive and is harmless.

! Be sure to shut off faucet and stop any function.

Go to Settings > E-Cleaning

: Select "Setting" in the home screen and touch "E-Cleaning".

Necessary time for cleaning: Approx. 3 hours

: The cleaning procedure will be displayed on the screen. Carry out cleaning according to this procedure.

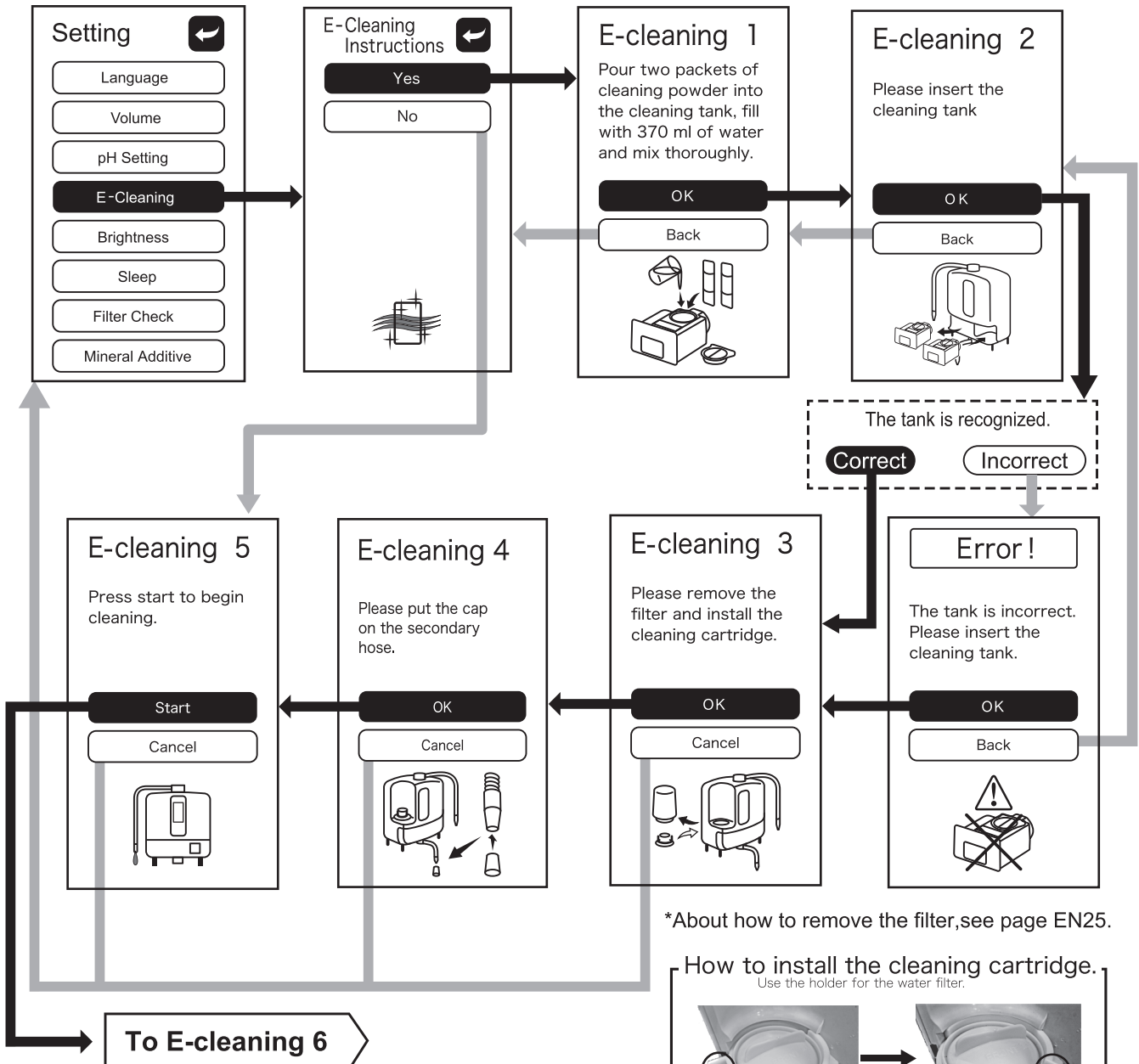

*About how to remove the filter, see page EN25.

! To ensure that the tank is correctly recognized, be sure to install the tank cover before using the tank.

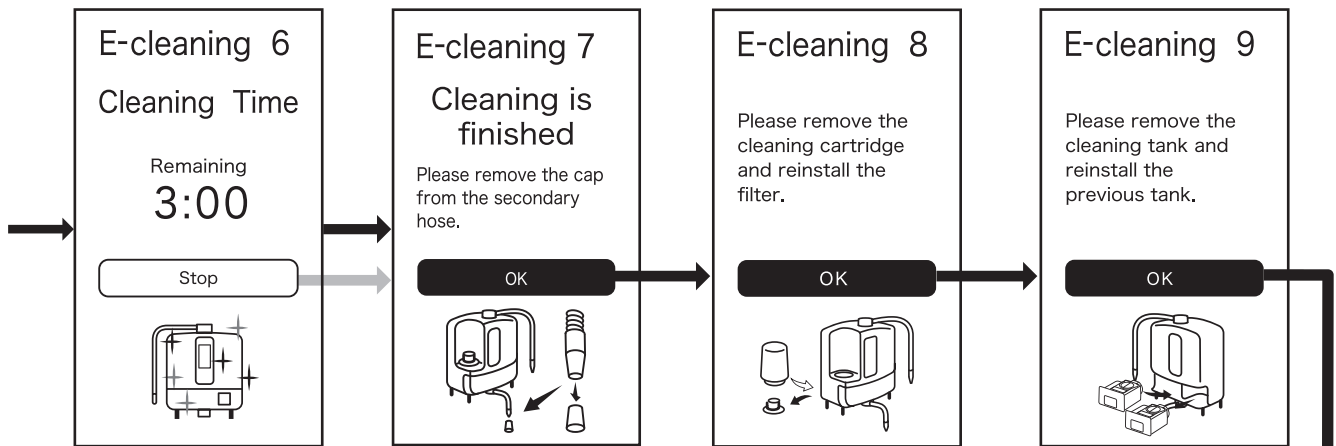

Attention

The water that flows out of pipe or hose is cleaning water, so do not use it.

Return to the Home screen

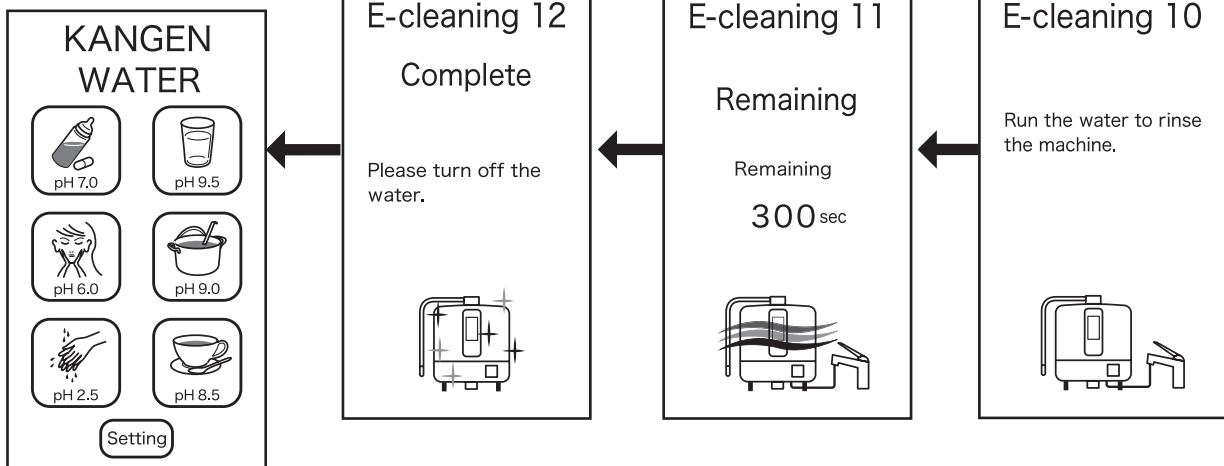

Attention



After using the cleaning tank, thoroughly rinse the tank with tap water, dry it completely with a soft cloth, and store in a dry place.

Cleaning machine

- Please do the E-cleaning once every one to two weeks. -
- We recommend deep cleaning once a year at a qualified service center.
- Deep cleaning intervals may vary, depending on hardness of source water.
- Water softener is recommended only for extremely hard water sources.

When this display appears

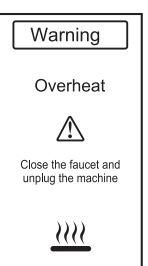
If any of the following messages is displayed on the screen, carry out the corresponding action. If the message remains displayed despite corrective action being taken, unplug the unit and contact the distributor from whom you purchased the unit.

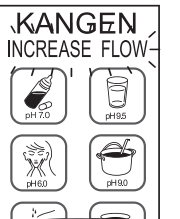
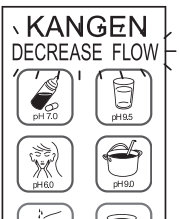
Screen display	Cause and necessary action	
	<p>This message is displayed if hot water at a temperature of at least 40°C is run through the unit and the hot water protection device operates.</p> <p>Voice “Hot water warning”</p>	<p>Immediately stop running hot water through the unit, and run water through it at a temperature of no more than 35°C. This message disappears when the temperature inside the main body of the unit falls.</p>
	<p>This message is displayed when the temperature inside the unit rises and the temperature detection device operates.</p> <p>Voice “Overheat warning”</p>	<p>Close the faucet and switch it off. Then wait for more than 30 minutes or longer depending on the environment.</p>
	<p>Voice “Please unplug the machine”</p>	
	<p>This message is displayed when the flow of the water is too slow.</p> <p>Voice “Increase flow”</p>	<p>Increase the water flow.</p>
	<p>This message is displayed when the flow of the water is too fast.</p> <p>Voice “Decrease flow”</p>	<p>Decrease the water flow.</p>

Continued on the next page.

Screen display

Cause and necessary action

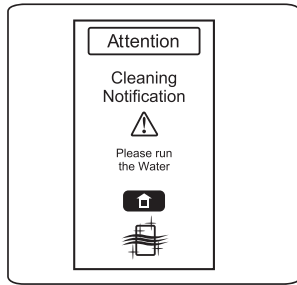

This message is displayed when cleaning is to be carried out at the beginning of the next water processing operation.

Run the water until the notification disappears (about 30 seconds).

Back to the home screen.

See page EN23

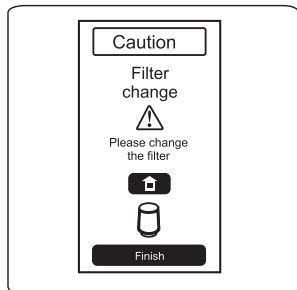

When water filter needs to be replaced.

Please replace the water filter.

Voice

"It's time to replace the filter"

Back to the home screen.

See page EN24

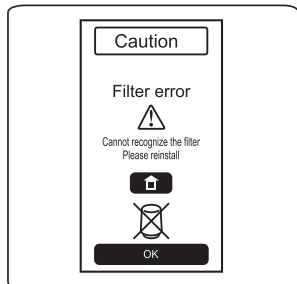

This message is displayed when a non-specified filter is installed.

This sometimes causes a reduction of function. Use our specified filter.

Back to the home screen.

See page EN26

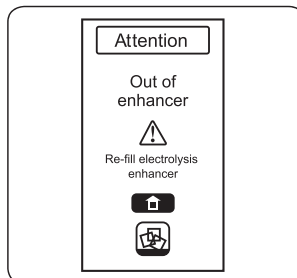

This message is displayed when the electrolysis enhancer is used up while strong acidic water is being made, or when there is no electrolysis enhancer in the tank.

Close the faucet and add electrolysis enhancer before use.

Voice

"Re-fill electrolysis enhancer"

Back to the home screen.



This message is displayed when **the electrolysis enhancer tank** is not installed.

Close the faucet and install the electrolysis enhancer before use.

Voice

"Please install the electrolysis enhancer tank"

Back to the home screen.



This message is displayed when **the mineral solution tank** is not installed.

Close the faucet and install the mineral solution tank before use.

Voice

"Please install the mineral solution tank"

Back to the home screen.

Troubleshooting

Trouble	Cause	Remedy
Nothing is displayed.	The power cord is not connected to the power outlet or the unit.	Check the connection.
The screen suddenly disappears.	Sleep function	See page EN17.
Water does not flow in cold weather.	The inside the unit is frozen.	Raise the room temperature and wait unit it melts.
Output of all types of water is getting low.	Water flow (pressure) is low.	Open the faucet wider.
	Water filter has clogged.	Replace the water filter with a new one.
	Cleaning timing.	Carry out E-Cleaning.
KANGEN Water has chlorine odor.	The performance of the water purification filter is reduced.	Replace the water filter with a new one.
Whitish material is floating or has settled in KANGEN Water.	Calcium processed by electrolysis.	Harmless
	Cleaning timing.	Carry out E-Cleaning.
The inside of secondary water pipe is stained dark.	Oxidizing material , such as iron has adhered.	Harmless
Dropping pH value when processing KANGEN Water and Beauty Water.	Calcium buildup in the ionizing cell.	Touch the Beauty button  and run water for about 1 minute to clean the ionizing cell.
	Cleaning timing.	Carry out E-Cleaning.



Safety Precautions

To avoid injury or accident, please adhere to the following rules.

Warning

 <p>Be sure to observe</p>	<ul style="list-style-type: none"> ● Please take the following precautions prior to drinking KANGEN Water. <ul style="list-style-type: none"> ● Do not take medication with KANGEN Water. ● If you are experience any discomfort in your health condition, please consult your physician or pharmacist. ● If you are under a physician care, or are experiencing physician care, or are experiencing physical abnormality, please consult your physician before using. ● Use only municipally treated water approved for drinking such as tap water. <ul style="list-style-type: none"> ● The unit's chlorine removal ratio and pH value may vary according to the water quality of different localities.
	<ul style="list-style-type: none"> ● Please supervise children and senior citizens while they use the machine. ● This appliance can be used by children age from 8 years and above and persons with reduced physical, Sensory or mental capabilities or lack of experience and knowledge if they have been given supervision or Instruction concerning use of the appliance in a safe way and understand the hazards involved. Children shall not play with the appliance. Cleaning and user maintenance shall not be made by children without supervision.
	<ul style="list-style-type: none"> ● Failure to comply with all of the following warnings may cause electric shock, fire or accidents and can result in severe personal injury and or damage to property. <ul style="list-style-type: none"> ● Do not splash water or oil on the body. ● Never run the unit with a damaged power supply cord. ● Do not tamper with or attempt to repair the unit.
	<ul style="list-style-type: none"> ● Stop use immediately and unplug the power plug when there are aberrations or malfunctions. <p>Failure to do this may cause smoke generation, fire ignition or electric shock. Unplug the power plug, have the product inspected and repaired.</p>

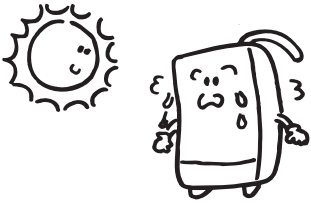
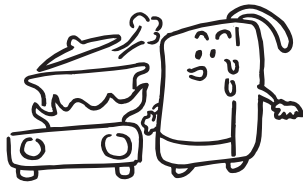
Attention

 <p>Please observe</p>	<ul style="list-style-type: none"> ● Avoid direct sunlight. <p>- May cause the unit to bend or warp.-</p> 	<ul style="list-style-type: none"> ● Do not place the unit near hot objects or in the presence of corrosive gas. <p>- May damage or cause the unit to bend or warp.-</p> 
	<ul style="list-style-type: none"> ● Never place anything on the unit. <p>- It may cause damage or fall.-</p> 	<ul style="list-style-type: none"> ● Do not use thinner, benzene, cleansers or chlorine-based detergents for cleaning. <p>- May damage the unit. -</p> 

⚠ Attention

- **Never run hot (40°C or higher) into the unit.**
- It may damage or cause malfunctions.-

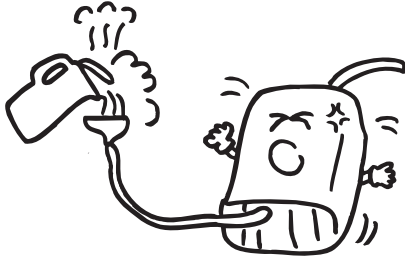

- **Do not use salt water or excessively hard water.**

- The unit may be damaged, or its service life will be shortened.-

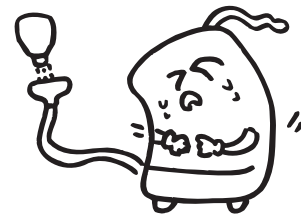

- **Do not use the unit when the secondary water hose is in an elevated position.**

- Water cannot flow out of the unit and therefore it may cause damage.-

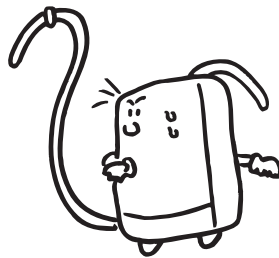

- **If you want to move the unit, first remove the electrolysis enhancer tank.**

- Leaking from the electrolysis enhancer may cause trouble.-

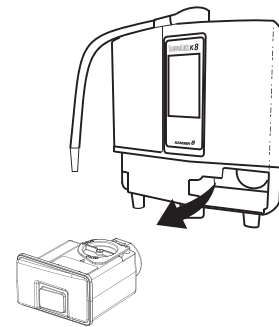

Please observe

- **Do not use processed water in aquariums or give to pets.**

- The unit may be damaged, or its service life will be shortened.-

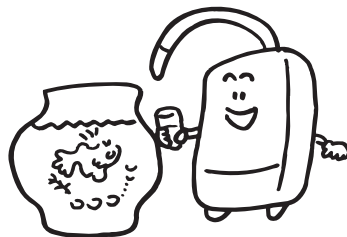

- **When using the unit in a area with cold temperatures please avoid running freezing water into the unit (When you are not using the unit for a long period of time, remove the water filter and keep it separately from the unit. At the time, do not touch the reset switch).**

- Failure to do so can result in damage or malfunction.-



① Flexible pipe
32in./800mm long

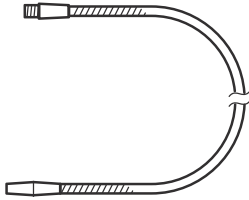

② Water supply hose
(40 ~ 200in./1 ~ 5m)

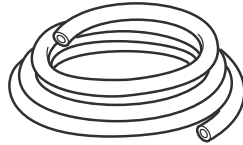

③ Secondary water hose
(40 ~ 200in./1 ~ 5m)

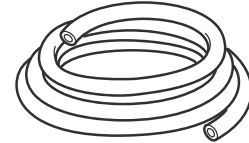

④ Mineral solution tank set

- Mineral solution tank (With additive cap)
- Calcium lactate 200 g



⑤ Electrolysis enhancer



⑥ Cleaning tank



⑦ Water filter for replacement
Activated charcoal type
F-8



⑨ Screw fixed adapter



⑧ Cleaning powder
(24 pcs.)



⑩ Secondary water hose set

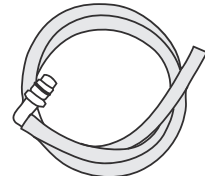

Install the secondary water hose set.

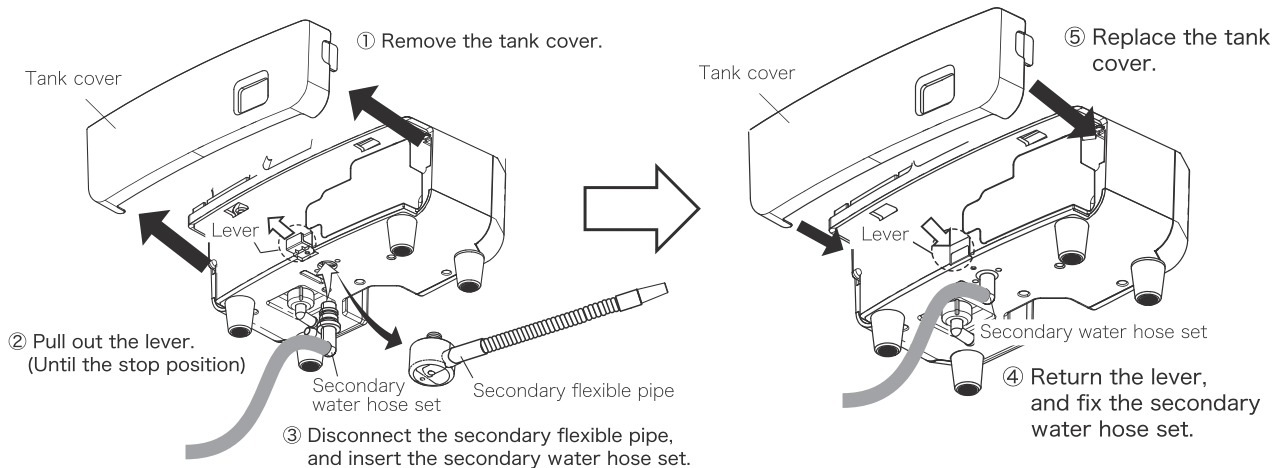

Standard specifications

Item name		Leveluk K8		
Feed water specs and connection		One way diverter		
Power supply Rated current		100-240 V AC 50-60 Hz 2.6-1.1 A		
Power consumption		Approx. 230 W (When using pH9.5)		
Main unit	dimensions	Approx. H 13.6 × W 11.0 × D 5.8 inch (H 34.5 × W 28.0 × D 14.7 cm)		
	weight	11 lbs (5 kg)		
Ionizing system		Continuous ionizing system (Built-in flow rate sensor)		
Electrolysis	KANGEN Water	0.92 gal/min (3.5 L/min)		
	Feed water pressure Approx.	14.3 psi (100 kPa)		
	Strong Acidic Water	0.34 gal/min (1.3 L/min)		
	Feed water pressure Approx.	14.3 psi (100 kPa)		
	Electrolysis capacity settings	7 level	KANGEN Water at 3 levels (Approx. pH8.5/pH9.0/pH9.5) Clean Water (Approx. pH7.0) Beauty Water (Approx. pH6.0) Strong Acidic Water (Approx. pH2.5) Strong KANGEN Water (Approx. pH11.0)	
	Cleaning system of ionizing cell	· When KANGEN water, Beauty water or Strong Acidic water has been used for more than 10 minutes (10 seconds when the water is stopped) · When water is not passed through the unit for 24 hours (30 seconds)		
	Materials of electrode and ionizing cell	Platinum-plated titanium		
Water filter	Filter material	Granulated antibacterial activated charcoal, calcium sulfite		
	Removable substance	Aesthetic Chlorine, Taste and Odor up to 1,500 gallons (6,000 liters)		
	Un-removable substance	Metal ions/salt dissolved in original tap water		
	Replacement interval	When water is passed through the unit for about one year, or 6,000 liters have been passed through it (Varies according to region and water quality)		
Applicable water pressure		50 kPa - 500 kPa (Approx. 0.5 kgf/cm ² - 5 kgf/cm ²)		
Available water temperature		41-95 °F (5-35 °C)		
Electrolysis enhancer (for Strong Acidic Water production)		Forced dissolving adding type		
Electrolysis enhancer (sodium chloride)re-fill need indication		Voice guidance, LCD message		
Protective device		Current fuse 250 V-3.15 A Heat Protect		
Detective device		Detection of temperature rise and hot water		
Electric shock protection class		Class I		
IP Code		IPX1		
Length of power code		Approx. 2m		

- Specifications and design subject to change for product improvements without notice.
- The electrolytic processing capacity and the filter service life largely depend on the water quality or how the machine was used.

After-sales Service

Warranty

- Please keep the included warranty in a safe place for future reference.

If you need repair during warranty period

- For repairs, please contact your local dealer.
(Please read the warranty carefully, some repairs may not be covered under the warranty.)

Attention *You may be charged if your repair is for any of the following reasons.

1. Trouble resulting from handling in a manner that is not specified in the "Operation Manual".
2. Trouble or damage due to the use of water other than municipal drinking water.
3. Trouble or damage due to natural disaster, such as, earthquake, fires or floods.
4. Dropping the product or damage caused during transportation.
5. Damage caused by use of improper voltage.
6. Replacement of consumable parts.
7. Replacement of spent electrode.
8. Trouble resulting from improper usage or failure to perform regular maintenance.
9. Trouble resulting from tampering or altering.
10. Trouble caused by sediment or lime scale deposits.

If you need to repair after warranty expiration

- Contact your local dealer. Repair may be available upon request at purchaser's expense.

Others

- If you have any questions about the product, please contact your dealer.
- For use with cold water only.
- Do not use with water that is microbiologically unsafe or of unknown quality without adequate disinfection before or after the system.
- Water pipe connections and fixtures directly connected to a potable water supply shall be sized, installed, and maintained in accordance with federal, state, and local codes.

Warning



In no case should the product be modified, overhauled or repaired by purchaser, as fire or electrical shock could result.
Any consequences of such behavior shall not be compensated by the maker.